

ISCAR New Products

Metric Version 2022



NEOLOGIQ
MACHINING INTELLIGENTLY

NEOTA
NEO ISCAR TOOL ADVISOR

Find The NEOLOGIQAL Tool For Your Application!

- The virtual tool advisor features advanced AI and 'Big Data' analytics
- Supports with complicated machining tasks and challenges
- Offers a wide range of functions and recommendations to operate machining centers
- Features online service 24/7 in more than 30 languages
- Functions according to ISO 13399 standard



Member IMC Group
iscar
www.iscar.com

Available now on ISCAR.COM

NEO ITA System Workflow



Select a Machine



Define and customize machine specifications



Search material by groups or by random choice



Choose a Tool Recommendation



and the ISCAR World App



TURNING PRODUCTS

PICCO-INDEX.....	4
NEOPASS.....	6
NEOSWISS INDEXABLE HEADS.....	8
NEOSWISS Y-AXIS.....	14
NEOMODU.....	18
ISO TURN Y-AXIS.....	20
70 ANGLE INSERTS.....	24
LOGIQ-F-GRIP.....	28
JET-CROWN.....	34
LOGIQ-F-GRIP Y-AXIS.....	36
TANG-GRIP Y-AXIS.....	38
SWISS-GRIP.....	40

HOLE MAKING PRODUCTS

LOGIQ-3-CHAM.....	44
SOLID-DRILL.....	48

MILLING PRODUCTS

NEODO.....	56
LOGIQ-4-FEED.....	60
HELI-SLOT.....	62
NEO-FEED.....	66
MULTI-MASTER.....	70
NEO-BARREL.....	74

ADAPTATION PRODUCTS

NEO-COLLET.....	78
-----------------	----

CUTTING MATERIALS

GRADES.....	82
-------------	----





NEOLOGIQ TURN

MACHINING INTELLIGENTLY



TANG-GRIP
Y AXIS PARTING LINE



ISOYTURN
Y AXIS



LOGIQ FGRIP
HIGH FEED GRIP HOLDER



PICCOINDEX
INDEXABLE INSERTS



SWISSGRIP
NARROW WIDTHS



New Solid Carbide Tools

PICCOINDEX
INDEXABLE INSERTS

New PICCOINDEX Solid Carbide Tools with Indexable Inserts for **Machining Miniature Parts** and Increased Tool Life



**200%
Increased
Tool Life**

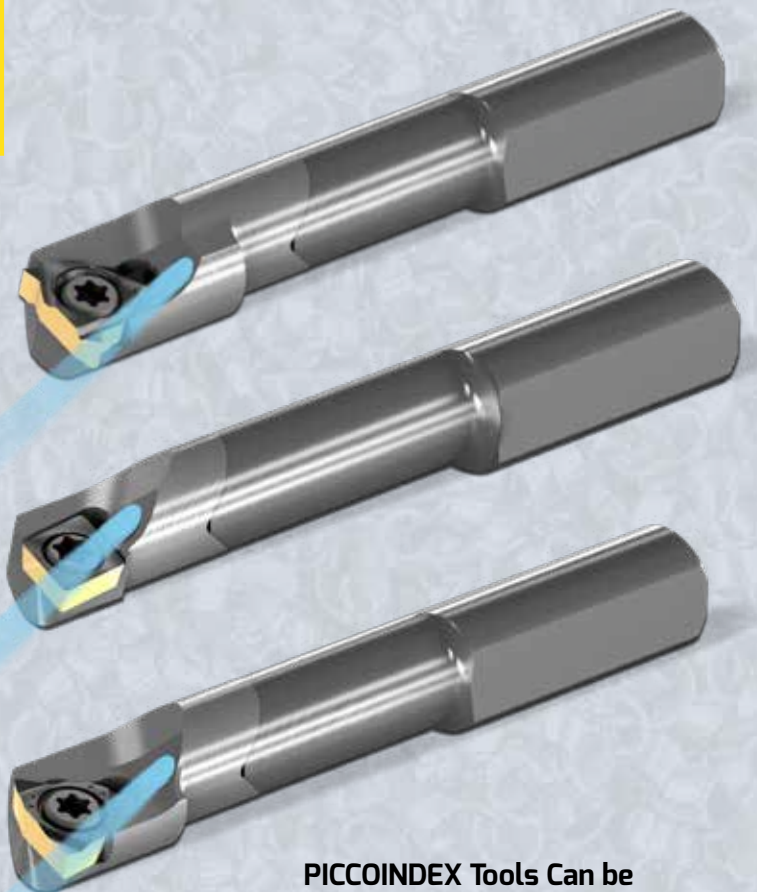

PICCOINDEX Tools Can be Mounted on PASSCUT Holders and the NEOPASS Holder

VIDEO



PICIN-SCLCR/L
Solid Carbide PICCO Tools
Carrying 80° Rhombic Inserts

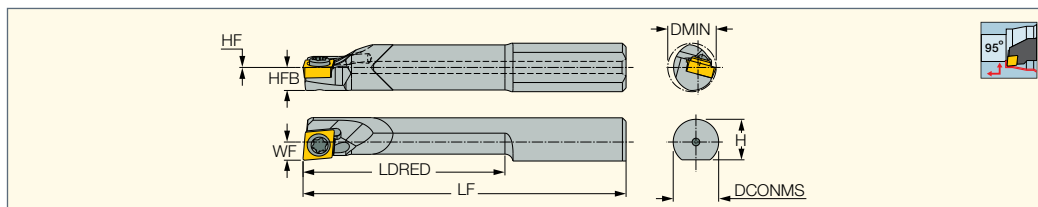



Designation	DCONMS	LF	LDRED	H	HFB	WF	DMIN	HF	CSP ⁽¹⁾	MIID ⁽²⁾
PICIN E05-T20-SCLCR/L-03	5.00	35.00	20.0	4.5	2.1	1.85	4.50	0.0	1	CCGT 03X101-F1P
PICIN E06-T25-SCLCR/L-03	6.00	40.00	25.0	5.4	2.9	2.25	6.00	0.0	1	CCGT 03X101-F1P

⁽¹⁾ 0 - Without coolant supply, 1 - With coolant supply

⁽²⁾ Master insert identification

Spare Parts

Designation		
PICIN-SCLCR/L	CSTA-1.6	T-6/5

PICIN-MGSIR/L
Solid Carbide PICCO Tools
Carrying Internal Laydown
Threading Inserts

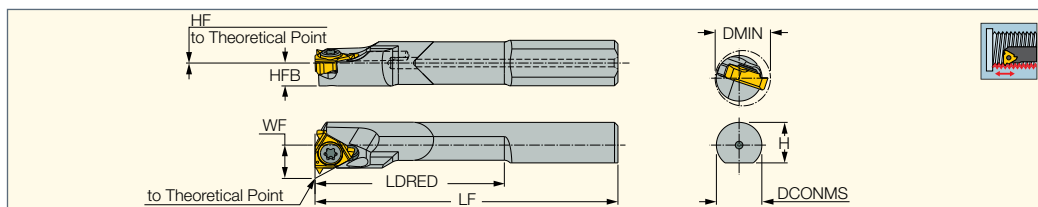



Designation	DCONMS	LF	LDRED	H	HFB	WF	DMIN	HF	CSP ⁽¹⁾	MIID ⁽²⁾
PICIN E06-T25-MGSIL-06	6.00	40.00	25.0	5.4	3.0	4.41	7.30	0.0	1	06L A 55
PICIN E06-T25-MGSIR-06	6.00	40.00	25.0	5.4	3.0	4.41	7.30	0.0	1	06IR A 55

• B-steel shank with coolant hole, CB-carbide shank with coolant hole • All toolholders provide 1.5° helix angle, either via the pocket or the anvil supplied • For GTGA inserts, use anvil AL 16-0

⁽¹⁾ 0 - Without coolant supply, 1 - With coolant supply

⁽²⁾ Master insert identification

Spare Parts

Designation		
PICIN-MGSIR/L	SR 14-552	T-6/5

PICIN-SWUBR/L
Solid Carbide PICCO Tools
Carrying Small WBMT/
WBGT Trigon Inserts

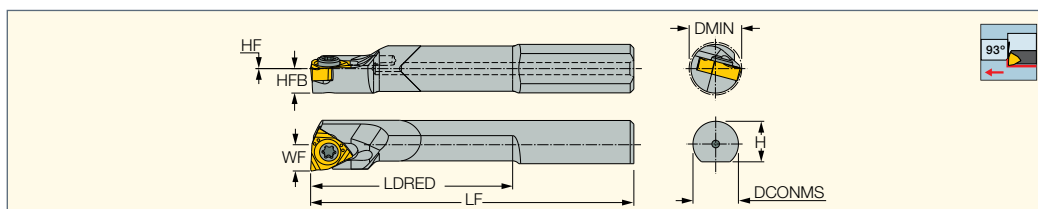



Designation	DCONMS	LF	LDRED	H	HFB	WF	DMIN	HF	CSP ⁽¹⁾	MIID ⁽²⁾
PICIN E06-T25-SWUBL-06	6.00	40.00	25.0	5.4	3.0	3.25	6.50	0.0	1	WBMT 060101R
PICIN E06-T25-SWUBR-06	6.00	40.00	25.0	5.4	3.0	3.25	6.50	0.0	1	WBMT 060101L

• Use right-hand WBMT 06...R inserts on left-hand tools and left-hand WBMT 06...L inserts on right-hand tools.

⁽¹⁾ 0 - Without coolant supply, 1 - With coolant supply

⁽²⁾ Master insert identification

Spare Parts

Designation		
PICIN-SWUBR/L	SR 14-552	T-6/5



Smart Holder for Small Part Boring

NEOPASS
PICCO LINES HOLDER

Smart Holder Can Mount All Types of Picco Heads. Features **Unique Coolant Outlets** for Increased Tool Life.



**200%
Increased
Tool Life**



**A Wide Variety
of Tools and Inserts**
Options for Machining
Miniature Parts

PICCOJET
COOLANT THROUGH

**Internal
Coolant
Outlet**

PICCOINDEX
INDEXABLE INSERTS

**Internal
Coolant
Outlet**

PICCO CUT
MINI BORING



PICMU

Holders with Improved Cooling Supply Suitable for Mounting PICCO-CUT, PICCO-JET Inserts and PICCO-INDEX Tools.

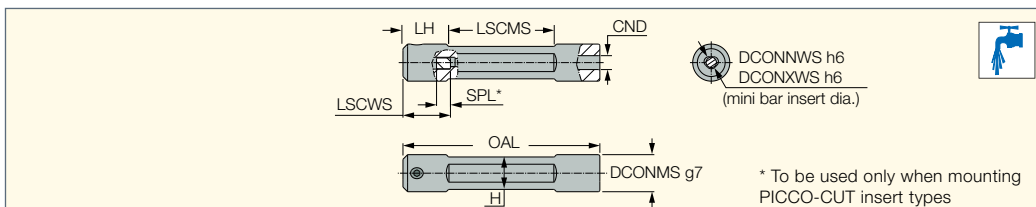

Designation	DCONMS	DCONNWS ⁽¹⁾	DCONXWS ⁽²⁾	OAL	LH	LSCMS	H	LSCWS	CND	SPL ⁽³⁾
PICMU 12-4	12.00	4.00	4.05	85.00	19.7	45.60	11.0	19.00	5.00	6.00
PICMU 12-5	12.00	5.00	5.05	85.00	19.7	45.60	11.0	20.50	6.00	6.00
PICMU 16-4	16.00	4.00	4.05	85.00	19.7	45.60	14.0	19.00	5.00	6.00
PICMU 16-5	16.00	5.00	5.05	85.00	19.7	45.60	14.0	20.50	6.00	6.00
PICMU 16-6	16.00	6.00	6.05	85.00	19.7	45.60	14.0	20.50	6.00	6.00
PICMU 16-7	16.00	7.00	7.05	85.00	19.7	45.60	14.0	20.80	8.00	7.00
PICMU 20-4	20.00	4.00	4.05	85.00	19.7	45.60	18.0	19.00	5.00	6.00
PICMU 20-5	20.00	5.00	5.05	85.00	19.7	45.60	18.0	20.50	6.00	6.00
PICMU 20-6	20.00	6.00	6.05	85.00	19.7	45.60	18.0	20.50	6.00	6.00
PICMU 20-7	20.00	7.00	7.05	85.00	19.7	45.60	18.0	20.80	8.00	7.00
PICMU 20-8	20.00	8.00	8.00	85.00	19.7	45.60	18.0	20.00	8.00	-
PICMU 22-4	22.00	4.00	4.05	85.00	19.7	45.60	20.0	19.00	5.00	6.00
PICMU 22-5	22.00	5.00	5.05	85.00	19.7	45.60	20.0	20.50	6.00	6.00
PICMU 22-6	22.00	6.00	6.05	85.00	19.7	45.60	20.0	20.50	6.00	6.00
PICMU 22-7	22.00	7.00	7.05	85.00	19.7	45.60	20.0	20.80	8.00	7.00

• Holders are suitable for right- and left-hand inserts, and boring bars

⁽¹⁾ Minimum diameter

⁽²⁾ Maximum diameter

⁽³⁾ Spacer length

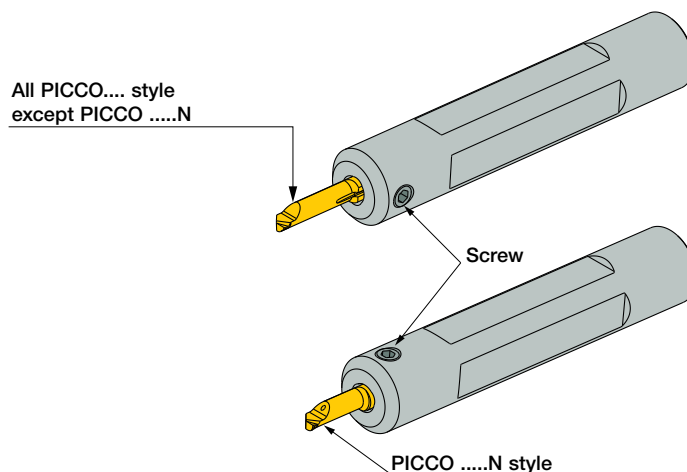

Spare Parts

Designation				
PICMU 12-4	SPACER D3.7X6	SR M5X0.5X6-PF	HW 2.5	PL 16 M6-D5
PICMU 12-5	SPACER D4.7X6	SR M5X0.5X6-PF	HW 2.5	PL 16 M6-D5
PICMU 16-4	SPACER D3.7X6	SR M5X0.5X6-PF	HW 2.5	
PICMU 16-5	SPACER D4.7X6	SR M5X0.5X6-PF	HW 2.5	PL 16 M6-D5
PICMU 16-6	SPACER D5.7X6	SR M6X0.5X6 PF	HW 3.0	PL 16 M6-D5
PICMU 16-7	SPACER D6.7X7	SR M6X0.5X6 PF	HW 3.0	PL 16 M6-D5
PICMU 20-4	SPACER D3.7X6	SR M5X0.5X6-PF	HW 2.5	PL 16 M6-D5
PICMU 20-5	SPACER D4.7X6	SR M5X0.5X6-PF	HW 2.5	PL 16 M6-D5
PICMU 20-6	SPACER D5.7X6	SR M6X0.5X6 PF	HW 3.0	PL 16 M6-D5
PICMU 20-7	SPACER D6.7X7	SR M6X0.5X6 PF	HW 3.0	PL 16 M6-D5
PICMU 20-8		SR M8X0.5X6.5-PF	HW 4.0	PL 16 M6-D5
PICMU 22-4	SPACER D3.7X6	SR M5X0.5X6-PF	HW 2.5	PL 16 M6-D5
PICMU 22-5	SPACER D4.7X6	SR M5X0.5X6-PF	HW 2.5	PL 16 M6-D5
PICMU 22-6	SPACER D5.7X6	SR M6X0.5X6 PF	HW 3.0	PL 16 M6-D5
PICMU 22-7	SPACER D6.7X7	SR M6X0.5X6 PF	HW 3.0	PL 16 M6-D5



Modular Swiss-Type Turning Holder

NEOSWISS
INDEXABLE HEADS

New System for Swiss-Type
Turning Machines with
Quick-Change Heads.
Features Minimum Setup Time.



**Fast Setup
Minimizes
Machine
Downtime**

A Variety of **Right**
and **Left** Heads
Can Be Mounted on
the **Same Shank**

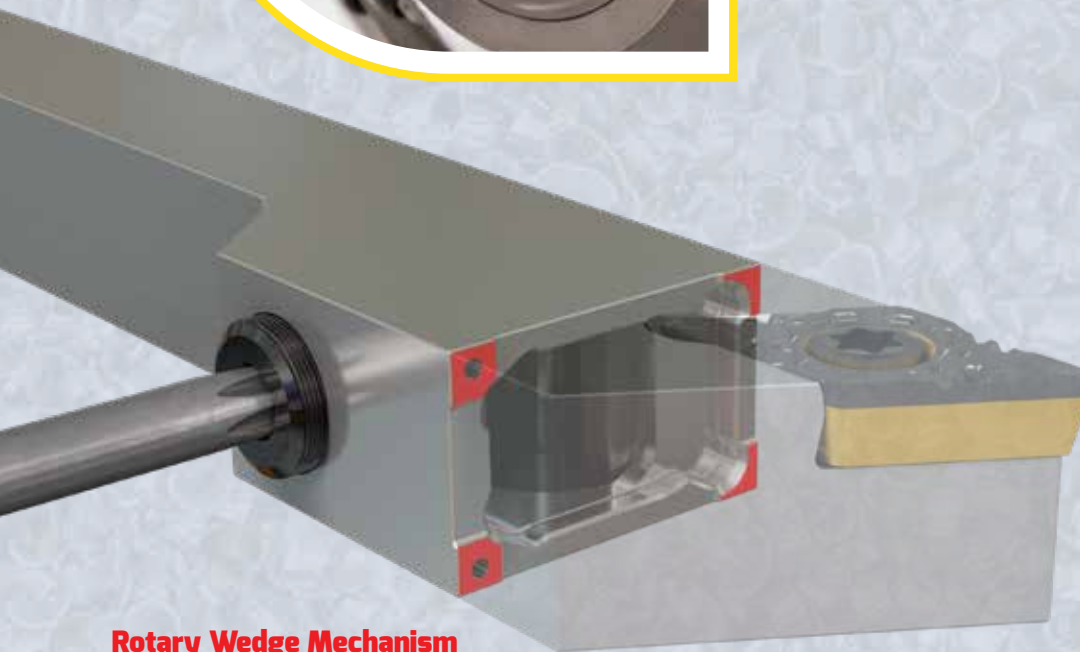

Rotary Wedge Mechanism
Designed to Amplify
the Clamping Force for
a Rigid Connection

VIDEO



NQCH-SCACR/L-JHP
Screw Lock Modular Heads
with High-Pressure Coolant - 7°
Clearance 80° Rhombic Inserts
for SwissType Machines

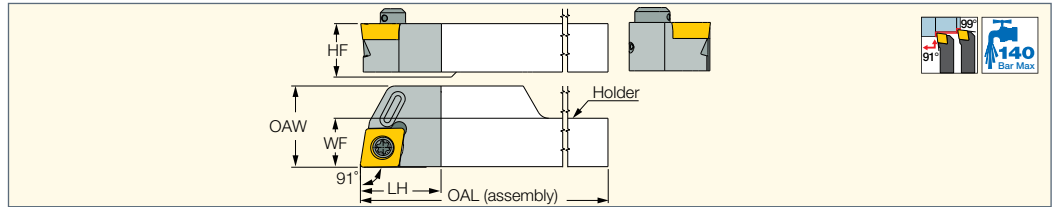

Designation	WF	HF	LH	OAL	OAW	Insert		
NQCH12-SCACR/L-09S-JHP	12.15	12.0	20.0	120.00	20.15	CC.. 09T3	SR 16-236	T-15/5
NQCH16-SCACR/L-09S-JHP	16.15	16.0	20.0	120.00	20.15	CC.. 09T3	SR 16-236	T-15/5

NQCH-SDACR/L-S-JHP
Screw Lock Modular Heads
with High-Pressure Coolant - 7°
Clearance 55° Rhombic Inserts
for SwissType Machines

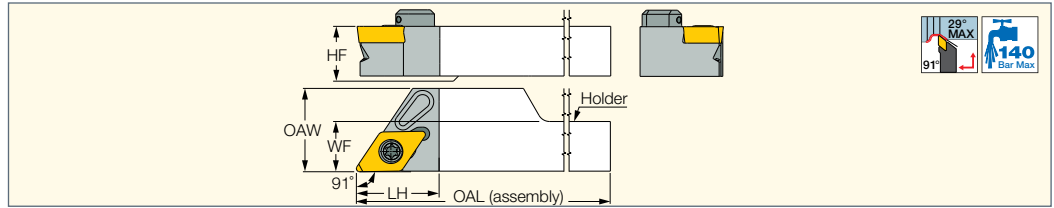

Designation	WF	HF	LH	OAL	OAW	Insert		
NQCH12-SDACR/L-11S-JHP	12.15	12.0	20.0	120.00	20.15	DC.. 11T3	SR 16-236 P	T-15/5
NQCH16-SDACR/L-11S-JHP	16.15	16.0	20.0	120.00	20.15	DC.. 11T3	SR 16-236 P	T-15/5

NQCH-SVACR/L-S-JHP
Screw Lock Modular Heads with
High-Pressure Coolant Carrying
7° Clearance 35° Rhombic
Inserts for SwissType Machines

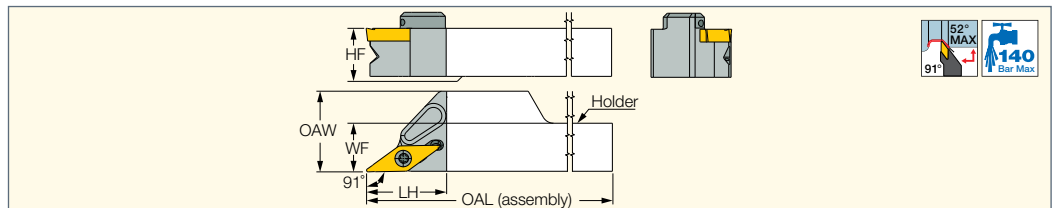

Designation	WF	HF	LH	OAL	OAW	Insert		
NQCH12-SVACR/L-11S-JHP	12.15	12.0	20.0	120.00	20.15	VC.. 1103	SR 14-560	T-8/5
NQCH16-SVACR/L-11S-JHP	16.15	16.0	20.0	120.00	20.15	VC.. 1103	SR 14-560	T-8/5

NQCH-SWLNR/L-S-JHP
Screw Lock Modular Heads
with High-Pressure Coolant -
Positive Double-Sided Trigon
Inserts for SwissType Machines

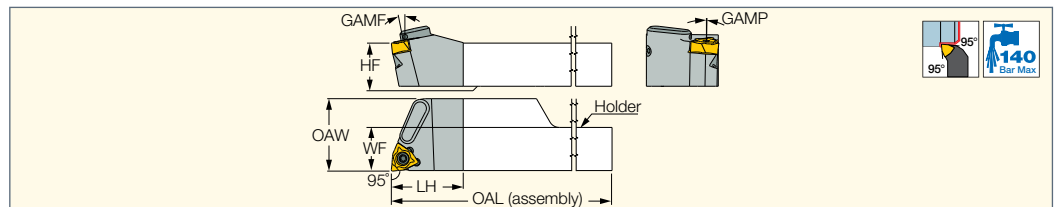

Designation	WF	HF	LH	OAL	OAW	GAMP	GAMF	Insert
NQCH12-SWLNR/L-04S-JHP	12.15	12.0	20.0	120.00	20.15	11.0	1.0	WNGP.. 0403
NQCH16-SWLNR/L-04S-JHP	16.15	16.0	20.0	120.00	20.15	11.0	1.0	WNGP.. 0403

Spare Parts

Designation		
NQCH-SWLNR/L-S-JHP	SR 34-514	T-7/5

NEOSWISS
INDEXABLE HEADS
MINI P TURN
POSITIVE DOUBLE SIDED

NQCH-SDJNR/L-S-JHP
Screw Lock Modular Heads with High-Pressure Coolant, Positive Double-Sided 55° Rhombic Inserts for Swiss-Type Machines

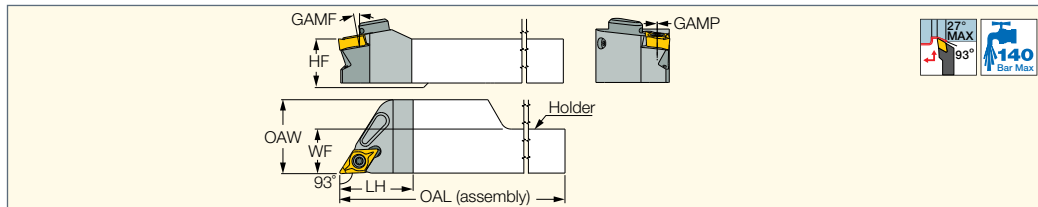

Designation	WF	HF	LH	OAL	OAW	GAMP	GAMF	Insert		
NQCH12-SDJNR/L-07S-JHP	12.15	12.0	20.0	120.00	20.15	0.0	10.0	DNGP.. 0703	SR 34-514	T-7/5
NQCH16-SDJNR/L-07S-JHP	16.15	16.0	20.0	120.00	20.15	0.0	10.0	DNGP.. 0703	SR 34-514	T-7/5

NEOSWISS
INDEXABLE HEADS
LOGIQ4 TURN
POSITIVE DOUBLE SIDED

NQCH-PCLXR/L-S-JHP
Lever Lock Modular Heads with High-Pressure Coolant, Positive Double-Sided 80° Rhombic Inserts for SwissType Machines

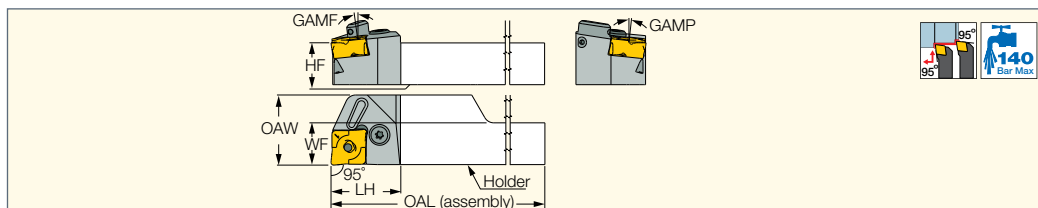

Designation	WF	HF	LH	OAL	OAW	GAMP	GAMF	Insert
NQCH12-PCLXR/L-09X-JHP	12.15	12.0	20.0	120.00	20.15	6.0	6.0	CXMG.. 0904
NQCH16-PCLXR/L-09X-JHP	16.15	16.0	20.0	120.00	20.15	6.0	6.0	CXMG.. 0904

Spare Parts

Designation		
NQCH-PCLXR/L-S-JHP	LR 3X SET	SR M6XL11.5V

NEOSWISS
INDEXABLE HEADS
ISOTURN

NQCH-Y-SDJCR-S-JHP
Y-Axis Screw Lock Modular Heads with High-Pressure Coolant - 7° Clearance 55° Rhombic Inserts for SwissType Machines

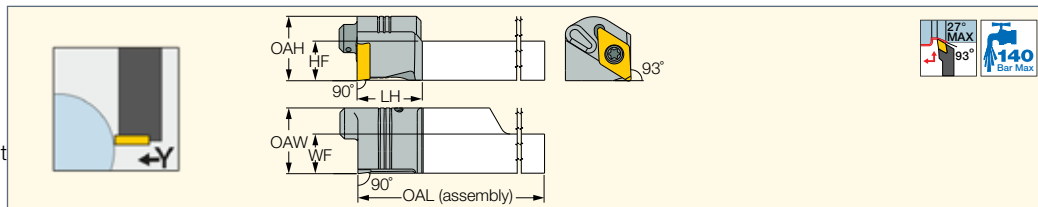

Designation	WF	HF	LH	OAL	OAW	Insert		
NQCH12-Y-SDJCR-11S-JHP	12.15	12.2	20.0	120.00	20.00	DC.. 11T3	SR 16-236 P	T-15/5
NQCH16-Y-SDJCR-11S-JHP	16.15	16.2	20.0	120.00	20.00	DC.. 11T3	SR 16-236 P	T-15/5



NQCH-Y-SVJCR-S-JHP

Y-Axis Screw Lock Modular Heads with High-Pressure Coolant - 7° Clearance 35° Rhombic Inserts for SwissType Machines

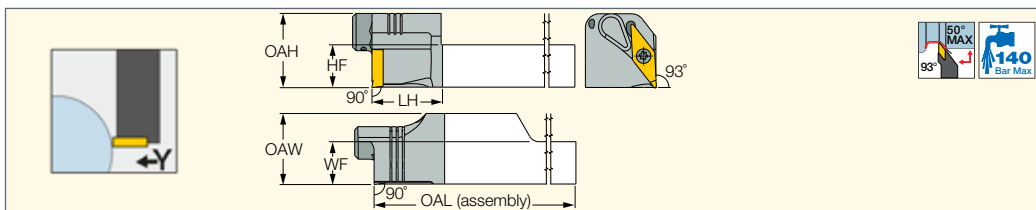

Designation	WF	HF	LH	OAL	OAW	Insert
NQCH12-Y-SVJCR-11S-JHP	12.15	12.2	20.0	120.00	20.15	VC.. 1103
NQCH16-Y-SVJCR-11S-JHP	16.15	16.2	20.0	120.00	20.15	VC.. 1103

Spare Parts

Designation		
NQCH-Y-SVJCR-S-JHP	SR 14-560	T-8/5

NQCH-PCHR/L-S-JHP

Screw Lock JETCUT Modular Heads Carrying PENTA Inserts for Grooving, Parting, and Recessing on Swiss-Type Machines

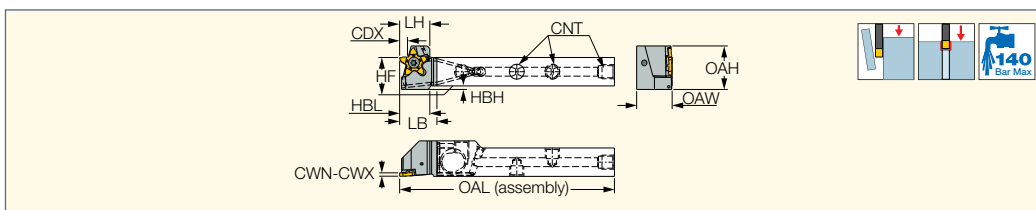



Designation	HF	OAW	LB	OAH	HBH	LH	OAL	HBL	CWN ⁽¹⁾	CWX ⁽²⁾	CDX	Insert
NQCH12-PCHR/LS-17-JHP	12.0	20.00	21.00	24.40	6.0	17.0	121.00	17.0	0.25	3.18	4.00	PENTA 17
NQCH16-PCHRS-17-JHP	16.0	20.00	21.00	24.50	2.0	17.0	121.00	17.0	0.25	3.18	4.00	PENTA 17

⁽¹⁾ Minimum cutting width

⁽²⁾ Maximum cutting width



Spare Parts

Designation		
NQCH12-PCHLS-17-JHP	SR M4-39432	T-1508/5
NQCH12-PCHRS-17-JHP	SR M4-39432L	T-1508/5
NQCH16-PCHRS-17-JHP	SR M4-39432L	T-1508/5

NQCH-SCHR/L-BF-JHP

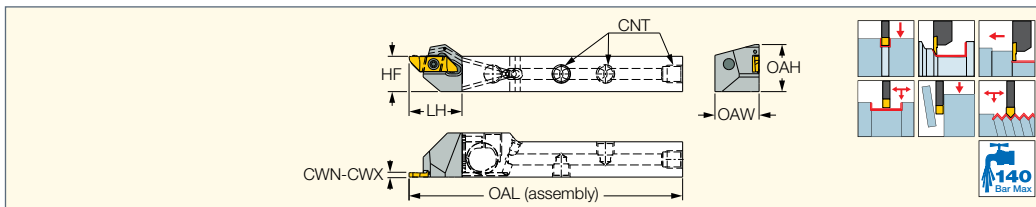
Screw Lock JETCUT Modular Heads for Swiss Type Machines - Grooving and Turning, Back or Front Clamped Inserts





Designation	HF	OAW	LH	OAH	OAL	CWN ⁽¹⁾	CWX ⁽²⁾	Insert		
NQCH12-SCHR/L-22BF-JHP	12.0	20.00	24.0	17.30	124.00	0.50	2.50	SCIR/L-22	SR M4X0.7-19425	T-8/5
NQCH16-SCHR/L-22BF-JHP	16.0	20.00	24.0	21.10	124.00	0.50	2.50	SCIR/L-22	SR M4X0.7-19425	T-8/5

⁽¹⁾ Minimum cutting width

⁽²⁾ Maximum cutting width

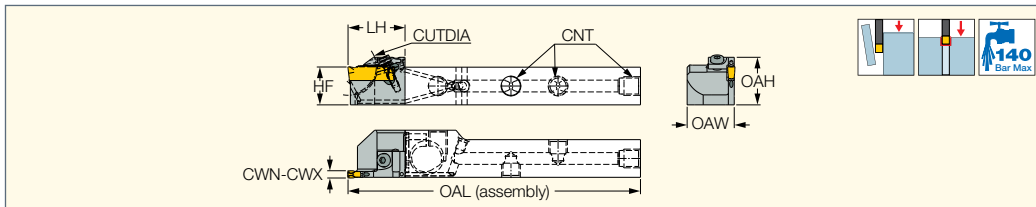
NQCH-DGTR/L-D-SH-JHP
Screw Lock JETCUT Modular
Heads for Swiss Type Machines
- Double-Sided Parting Inserts





Designation	CWN ⁽¹⁾	CWX ⁽²⁾	HF	OAW	OAH	LH	OAL	CUTDIA	Insert		
NQCH12-DGTL-2D24SH-JHP	1.90	2.50	12.1	20.00	16.20	24.0	124.00	24.0	DGN 2	SR M3X10DIN912	HW 2.5
NQCH12-DGTR-2D24SH-JHP	1.90	2.50	12.1	20.00	16.20	24.2	124.20	24.0	DGN 2	SR M3X10DIN912	HW 2.5
NQCH16-DGTL-2D24SH-JHP	1.90	2.50	16.1	20.00	20.20	24.0	124.00	24.0	DGN 2	SR M3X10DIN912	HW 2.5
NQCH16-DGTR-2D24SH-JHP	1.90	2.50	16.1	20.00	20.20	24.2	124.20	24.0	DGN 2	SR M3X10DIN912	HW 2.5
NQCH12-DGTL-3D24SH-JHP	3.00	3.18	12.1	20.00	16.20	24.0	124.00	24.0	DGN 3	SR M3X10DIN912	HW 2.5
NQCH12-DGTR-3D24SH-JHP	3.00	3.18	12.1	20.00	16.20	24.2	124.20	24.0	DGN 3	SR M3X10DIN912	HW 2.5
NQCH16-DGTL-3D24SH-JHP	3.00	3.18	16.1	20.00	20.20	24.0	124.00	24.0	DGN 3	SR M3X10DIN912	HW 2.5
NQCH16-DGTR-3D24SH-JHP	3.00	3.18	16.1	20.00	20.20	24.2	124.20	24.0	DGN 3	SR M3X10DIN912	HW 2.5

⁽¹⁾ Minimum cutting width
⁽²⁾ Maximum cutting width

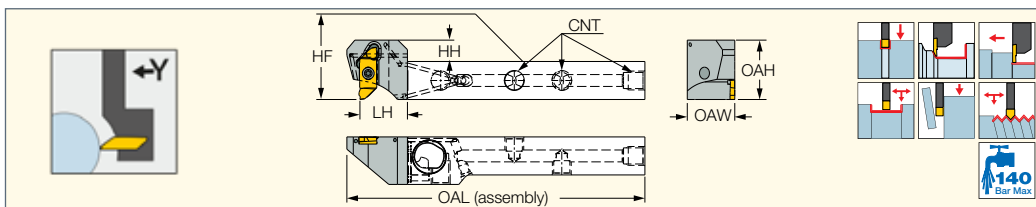
NQCH-Y-SCHR-BF-JHP
Y-Axis Screw Lock JETCUT
Modular Heads for Swiss Type
Machines - Grooving and Turning,
Back or Front Clamped Inserts



Designation	HF	OAH	LH	OAW	HH	OAL	CWN ⁽¹⁾	CWX ⁽²⁾	Insert		
NQCH12-Y-SCHR-22BF-JHP	12.0	25.00	20.0	20.00	13.0	125.50	0.50	2.50	SCIR/L-22-N/R/L	SR M4X0.7-19425	T-8/5
NQCH16-Y-SCHR-22BF-JHP	16.0	25.00	20.0	20.00	9.0	125.50	0.50	2.50	SCIR/L-22-N/R/L	SR M4X0.7-19425	T-8/5

⁽¹⁾ Minimum cutting width
⁽²⁾ Maximum cutting width

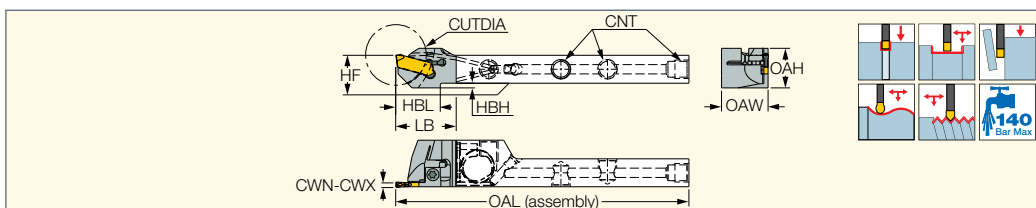

NQCH-GHSR/L-JHP
Screw Lock JETCUT Modular
Heads for Swiss Type Machines
- Grooving and Turning Inserts



Designation	HF	OAW	LB	OAH	HBH	OAL	HBL	CWN ⁽¹⁾	CWX ⁽²⁾	CUTDIA	Insert
NQCH12-GHSR/L-2-JHP	12.0	20.00	26.00	17.00	2.0	126.00	2.0	2.20	3.00	25.0	GIP 2
NQCH16-GHSR/L-2-JHP	16.0	20.00	26.00	19.00	-	126.00	-	2.20	3.00	25.0	GIP 2

⁽¹⁾ Minimum cutting width
⁽²⁾ Maximum cutting width

Spare Parts

Designation		
NQCH-GHSR/L-JHP	SR 16-236 P	T-15/3

NQCH-JHP

Square Shank with High-Pressure Coolant for NEOSWISS Modular Heads - Swiss Type Machines

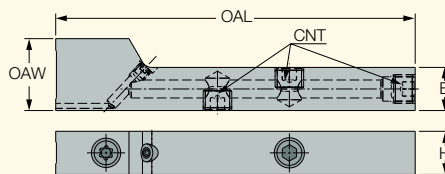

Designation	B	H	OAL	OAW	CNT
NQCH-1212-JHP	12.0	12.0	100.00	20.00	UNF 5/16-24
NQCH-1616-JHP	16.0	16.0	100.00	20.00	UNF 5/16-24

Clamping Operation Steps



Supplied Accessories	Item No: 7003805 SW6-T-SH	
	Item No: 7002553 BLD IP20/S7	
Recommended (Optional) Accessories	Item No: 7007221 TSA 6 5-14 N*m (TSA 6 44.1-123.5 lb*in)	
	Item No: 7007027 BLD 6 T20IP	

Attention: The clamping screw is not removable. To avoid undesired damage, do not apply excessive force when opening or clamping.

Spare Parts

Designation				
NQCH-JHP	SR 5/16UNF TL360	SW6-T-SH	BLD IP20/S7	SR M4X4 DIN913 TL360

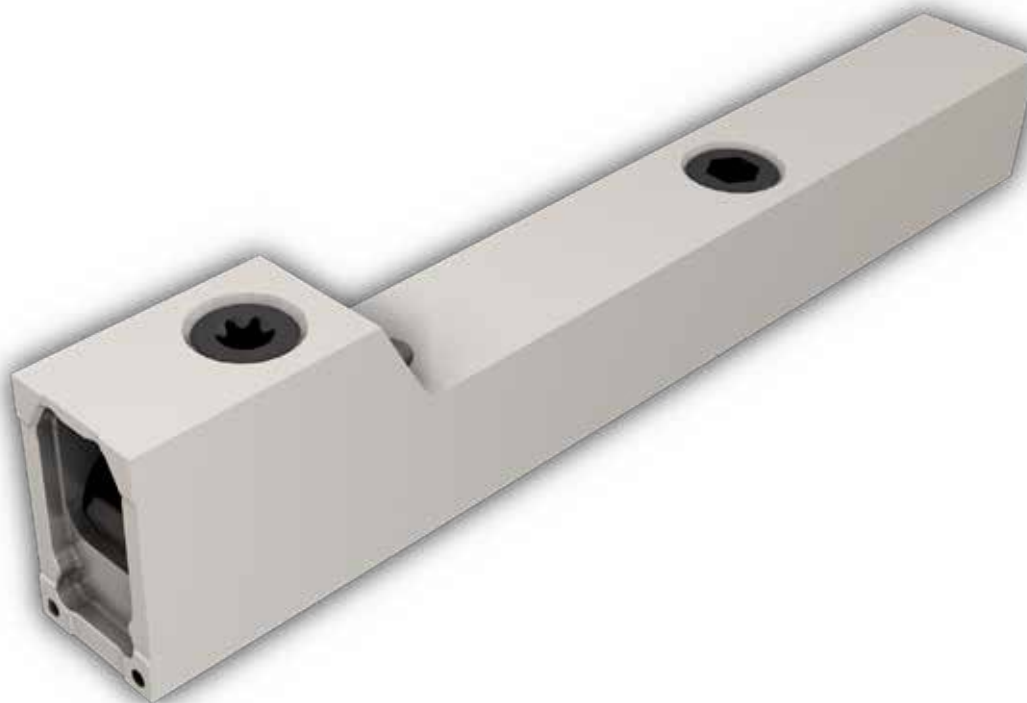



Y-Axis Swiss Type Machining

NEO^{AXIS}**Y****SWISS**

New **Y-Axis Turning and Grooving Holders** for Machining Miniature Parts on Swiss Type Machines. Suitable for Difficult-To-Cut Materials.



Bottom and Top
High Pressure Coolant



Excellent Chip Evacuation
and Stable Machining



PENTACUT

SWISSCUT

ISOTURN

VIDEO



NEO^{AXIS}SWISS

Y-SDJCR

Y-Axis Screw Lock Swiss-Type Tools that Mount 55° Rhombic Inserts with a 7° Clearance Angle

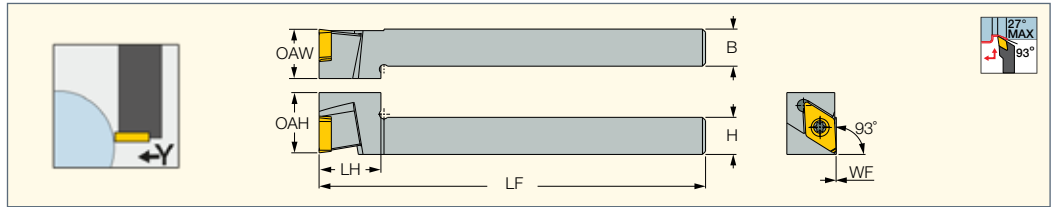

Designation	H	B	LF	LH	OAH	OAW	WF	Insert		
Y-SDJCR 1212K-11S	12.0	12.0	125.00	21.0	20.00	16.00	0.00	DCMT 11T3..	SR 35080I	T-15/5
Y-SDJCR 1616K-11S	16.0	16.0	125.00	21.0	20.00	16.00	0.00	DCMT 11T3..	SR 35080I	T-15/5

NEO^{AXIS}SWISS

Y-SDJCR-JHP

Y-Axis Screw Lock Swiss Tools with a JETCUT Coolant System that Mount 55° Rhombic Inserts with a 7° Clearance Angle

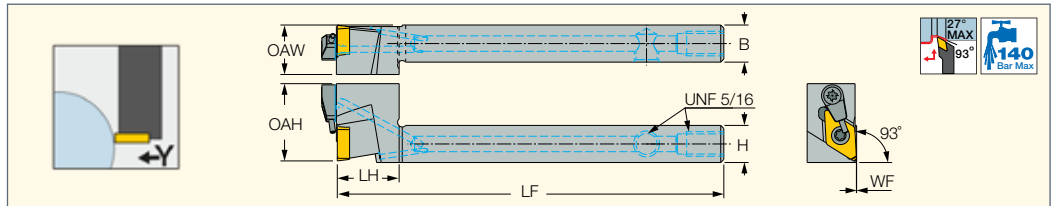

Designation	H	B	LF	LH	OAH	OAW	WF	Insert				
Y-SDJCR 1212K-11S-JHP	12.0	12.0	125.00	21.0	25.50	16.00	0.00	DCMT 11T3..	SR 35080I	T-15/5	HW 5/32"	SR 5/16UNF TL360
Y-SDJCR 1616K-11S-JHP	16.0	16.0	125.00	21.0	25.50	16.00	0.00	DCMT 11T3..	SR 35080I	T-15/5	HW 5/32"	SR 5/16UNF TL360

NEO^{AXIS}SWISS

Y-SVJCR

Y-Axis Screw Lock Swiss Type Tools that Mount 35° Rhombic Inserts with a 7° Clearance Angle

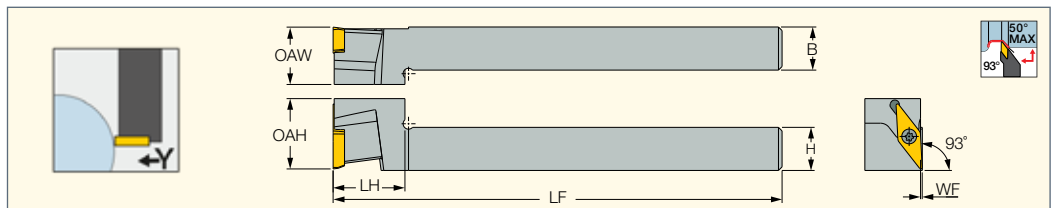

Designation	H	B	LF	LH	OAH	OAW	WF	Insert	
Y-SVJCR 1212K-11S	12.0	12.0	125.00	21.0	20.00	16.00	0.00	VCMT 1103..	T-7/5
Y-SVJCR 1616K-11S	16.0	16.0	125.00	21.0	20.00	16.00	0.00	VCMT 1103..	T-7/5

NEO^{AXIS}SWISS

Y-SVJCR-JHP

Y-Axis Screw Lock Swiss Tools with a JETCUT Coolant System that Mount 35° Rhombic Inserts with a 7° Clearance Angle

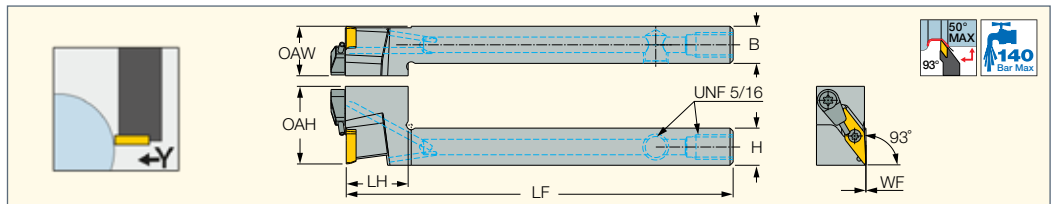

Designation	H	B	LF	LH	OAH	OAW	WF	Insert			
Y-SVJCR 1212K-11S-JHP	12.0	12.0	125.00	21.0	25.50	16.00	0.00	VCMT 1103..	T-7/5	HW 5/32"	SR 5/16UNF TL360
Y-SVJCR 1616K-11S-JHP	16.0	16.0	125.00	21.0	25.50	16.00	0.00	VCMT 1103..	T-7/5	HW 5/32"	SR 5/16UNF TL360

Y-PCHRS-17

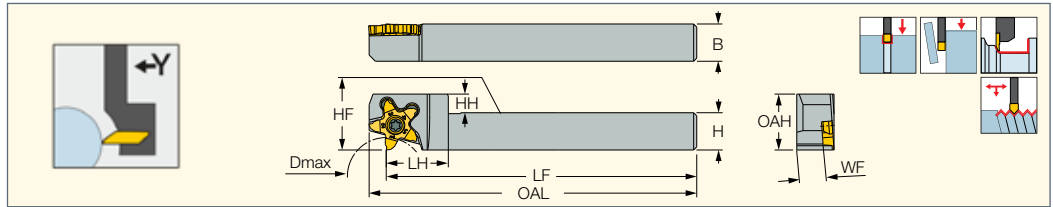

Y-Axis Swiss Type Tools -
5 Cutting Edged Inserts for
Grooving, Parting and Recessing
Next to High Shoulders



Designation	H	B	HH	LH	HF	WF	OAH	LF	OAL	D _{max}
Y-PCHRS 12-17	12.0	12.0	6.0	20.0	12.0	8.60	18.00	100.00	105.50	25.0 ⁽¹⁾
Y-PCHRS 16-17	16.0	16.0	2.0	20.0	16.0	12.30	18.00	125.00	130.50	38.0 ⁽¹⁾

- Use right-hand inserts on right-hand tools and vice versa
- ⁽¹⁾ for grooving

Spare Parts

Designation		
Y-PCHRS-17	SR M4-39432L	T-1508/5

Y-PCHRS-17-JHP

Y-Axis Swiss Type JETCUT Tools
- 5 Cutting Edged Inserts for
Grooving, Parting and Recessing
Next to High Shoulders

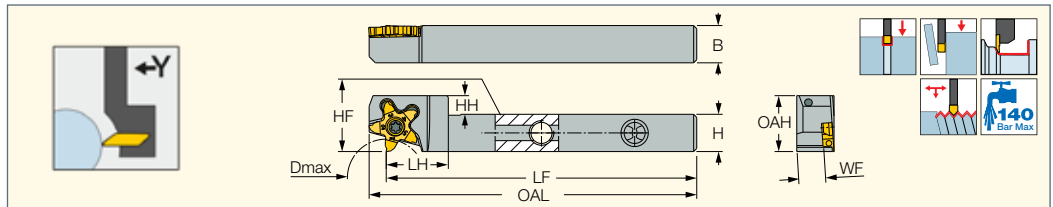

Designation	H	B	HH	LH	HF	WF	OAH	LF	OAL	D _{max}
Y-PCHRS 12-17-JHP	12.0	12.0	6.0	20.0	12.0	8.60	18.00	100.00	105.50	25.0 ⁽¹⁾
Y-PCHRS 16-17-JHP	16.0	16.0	2.0	20.0	16.0	12.30	18.00	125.00	130.50	38.0 ⁽¹⁾

- Use right-hand inserts on right-hand tools and vice versa
- ⁽¹⁾ for grooving

Spare Parts

Designation						
Y-PCHRS-17-JHP	SR M4-39432L	T-1508/5	SR M3X3DIN913	HW 5/32"	SR M4X3 DIN913	SR 5/16UNF TL360





NEO^{AXIS} SWISSCUT

Y-SCHR-22BF

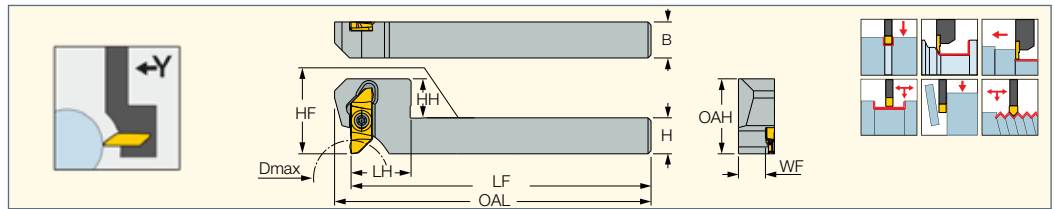
Y-Axis Tools for Swiss Type Machines - Back or Front Clamped Inserts for Grooving and Turning Operations



Designation	H	B	HH	LH	HF	WF	OAH	LF	OAL	D _{max}		
Y-SCHR 12-22BF	12.0	12.0	13.0	20.0	12.0	9.00	25.00	100.00	105.50	25.0 ⁽¹⁾	SR M4X0.7-19425	T-8/5
Y-SCHR 16-22BF	16.0	16.0	9.0	20.0	16.0	13.00	25.00	125.00	130.50	38.0 ⁽¹⁾	SR M4X0.7-19425	T-8/5

⁽¹⁾ for grooving

NEO^{AXIS} SWISSCUT JETCUT

Y-SCHR-22BF-JHP



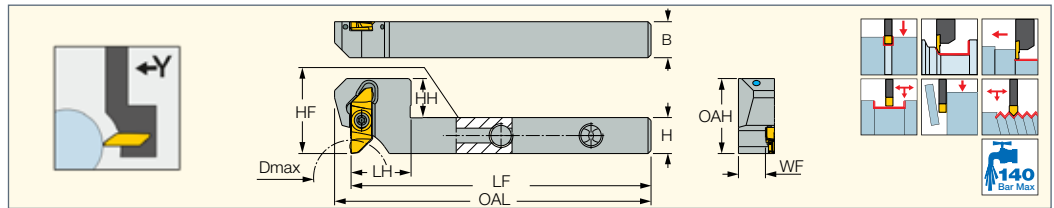



Y-Axis JETCUT Tools for Swiss Type Machines - Back or Front Clamped Inserts for Grooving and Turning Operations



Designation	H	B	HH	LH	HF	WF	OAH	LF	OAL	D _{max}
Y-SCHR 12-22BF-JHP	12.0	12.0	13.0	20.0	12.0	9.00	25.00	100.00	105.50	25.0 ⁽¹⁾
Y-SCHR 16-22BF-JHP	16.0	16.0	9.0	20.0	16.0	13.00	25.00	125.00	130.50	38.0 ⁽¹⁾

⁽¹⁾ for grooving

Spare Parts

Designation						
Y-SCHR-22BF-JHP	HW 5/32"	T-8/5	SR M3X3DIN913	SR M4X0.7-19425	SR M4X3 DIN913	SR 5/16UNF TL360





Interchangeable Turning Heads

NEOMODU
INDEXABLE TURNING HEADS

A New Line for External Turning
with **Interchangeable Heads**
For General Turning Applications.



External Square Shanks
25, 32 & 40 mm



Steel Eco Shank and Dedicated
External Interchangeable Heads

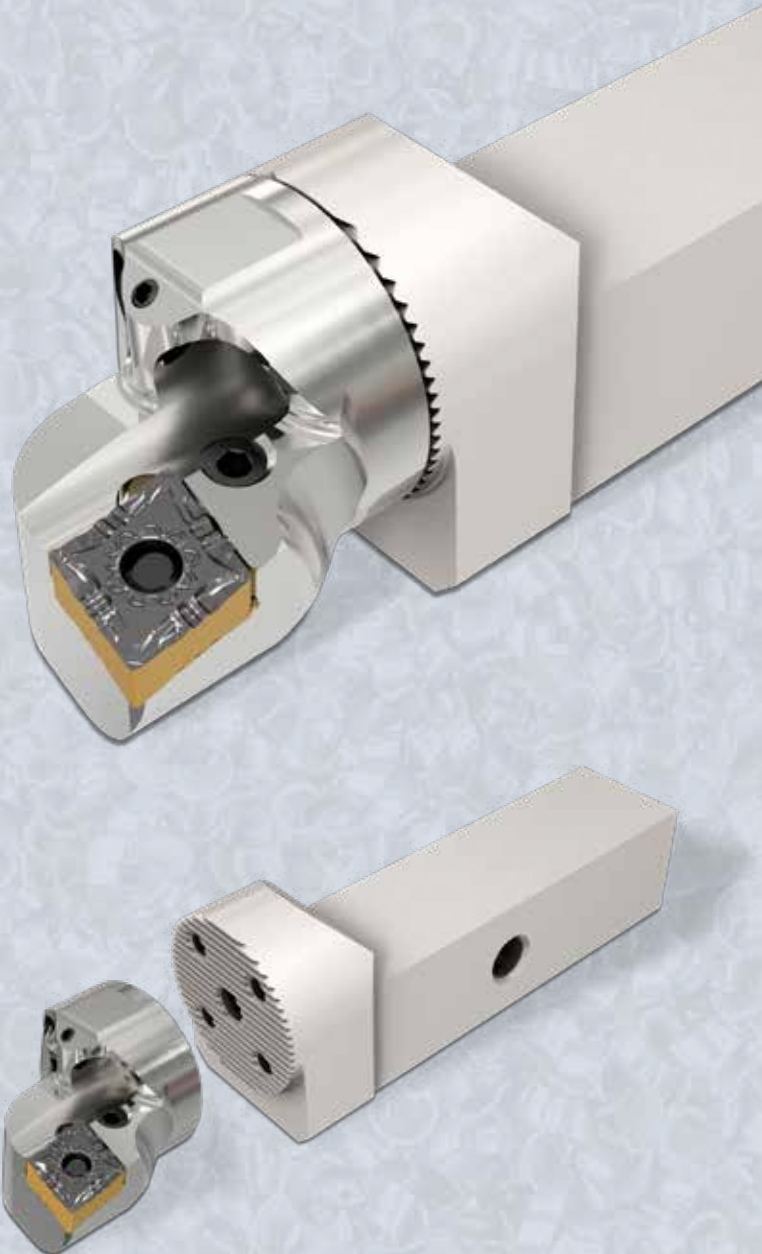

Straight Shank

ISOTURN



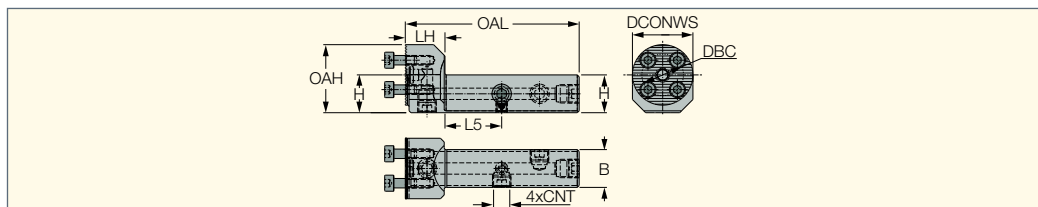

SH-S#-N-AVC

Square shank with serrated connection



Designation	DCONWS	LH	OAH	OAL	H	B	DBC	L5	CNT
SH-S2020-N-AVC-D20-JHP-MC	20.00	21.0	30.00	92.00	20.0	20.0	13.00	30.00	G 1/8
SH-S2020-N-AVC-D25-JHP-MC	25.00	21.0	32.50	92.00	20.0	20.0	16.00	30.00	G 1/8
SH-S2020-N-AVC-D32-JHP-MC	32.00	21.0	36.00	92.00	20.0	20.0	22.00	30.00	G 1/8
SH-S2525-N-AVC-D25-JHP-MC	25.00	21.0	37.50	107.00	25.0	25.0	16.00	36.00	G 1/8
SH-S2525-N-AVC-D32-JHP-MC	32.00	21.0	41.00	107.00	25.0	25.0	22.00	36.00	G 1/8
SH-S2525-N-AVC-D40-JHP-MC	40.00	21.0	45.00	107.00	25.0	25.0	28.00	36.00	G 1/8
SH-S3232-N-AVC-D32-JHP-MC	32.00	21.0	48.00	152.00	32.0	32.0	22.00	-	G 1/8
SH-S3232-N-AVC-D40-JHP-MC	40.00	26.0	52.00	152.00	32.0	32.0	28.00	-	G 1/8
SH-S4040-N-AVC-D40-JHP-MC	40.00	26.0	60.00	200.00	40.0	40.0	28.00	-	G 1/8

Spare Parts

Designation					
SH-S2020-N-AVC-D20-JHP-MC	SR M3.5X10 DIN912	SR M6X6 DIN913 TL360	HW 2.5	OR 5.6X1.8 NBR	PLG G1/8 TL360
SH-S2020-N-AVC-D25-JHP-MC	SR M4X12DIN912	SR M6X6 DIN913 TL360	HW 3.0	OR 5.6X1.8 NBR	PLG G1/8 TL360
SH-S2020-N-AVC-D32-JHP-MC	SR M5X12 DIN912	SR M6X6 DIN913 TL360	HW 4.0	OR 5.6X1.8 NBR	PLG G1/8 TL360
SH-S2525-N-AVC-D25-JHP-MC	SR M4X12DIN912	SR M6X6 DIN913 TL360	HW 3.0	OR 5.6X1.8 NBR	PLG G1/8 TL360
SH-S2525-N-AVC-D32-JHP-MC	SR M5X12 DIN912	SR M6X6 DIN913 TL360	HW 4.0	OR 5.6X1.8 NBR	PLG G1/8 TL360
SH-S2525-N-AVC-D40-JHP-MC	SR M6X16 DIN912	SR M6X6 DIN913 TL360	HW 5.0	OR 5.6X1.8 NBR	PLG G1/8 TL360





Y-Axis For Multi-Tasking Machines

ISO^Y^{AXIS}**TURN**

New **Y Axis Tool Holder** for Multi-Tasking Machines, Replaces Several Kinds of Turning Tools.

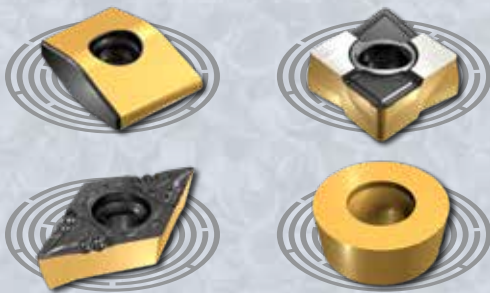

Lead Angle Can be Changed Which Enables **Insert Versatility Options**



HSK A63WH-SDJCN-13-Y

Y-Axis Turning Tools Carrying
55° Diamond Inserts with
7° Clearance Angle

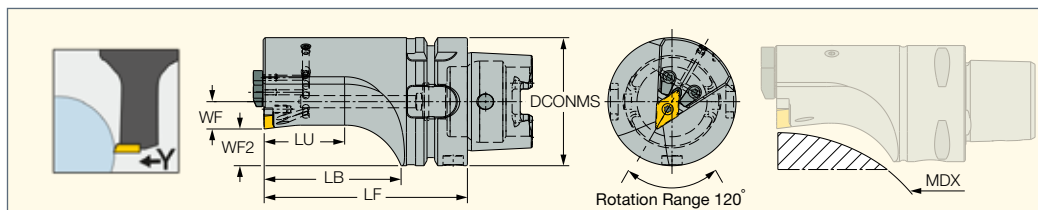

Designation	DCONMS	LU	LB	LF	WF	WF2	MDX ⁽¹⁾	MIID ⁽²⁾	CDI ⁽³⁾
HSK A63WH-SDJCN-13SL-100Y	63.00	39.60	67.40	100.00	13.44	18.1	215.00	DCMT 13T504-F3P-SL	0
HSK A63WH-SDJCN-13SL-125Y	63.00	64.60	92.40	125.00	13.44	18.1	390.00	DCMT 13T504-F3P-SL	0

• A cooling tube must be used with all coolant through HSK spindles (should be ordered separately).



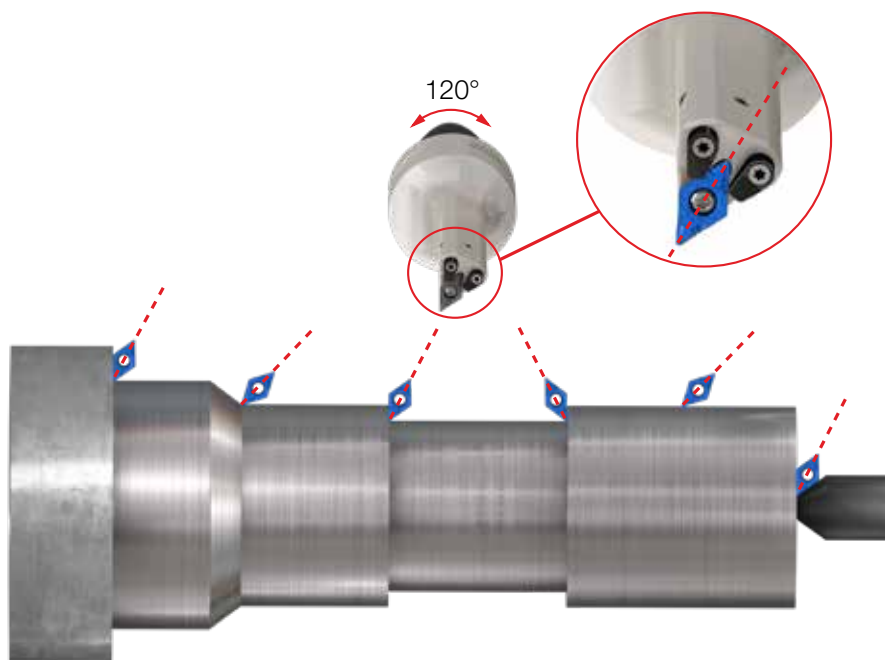

⁽¹⁾ Machinable diameter maximum

⁽²⁾ Master insert identification

⁽³⁾ 1 - Hole for data chip, 0 - Without hole for data chip



Spare Parts

Designation					
HSK A63WH-SDJCN-13-Y	CH-1.9D-JHP-A SET	BLD IP15/S7	SW6-T-SH	SR M4X4 DIN913 TL360	SR M4X0.7-L9.6 IP15

C#-SDJCN-13-Y

Y-Axis Turning Tools Carrying
55° Diamond Inserts with
7° Clearance Angle

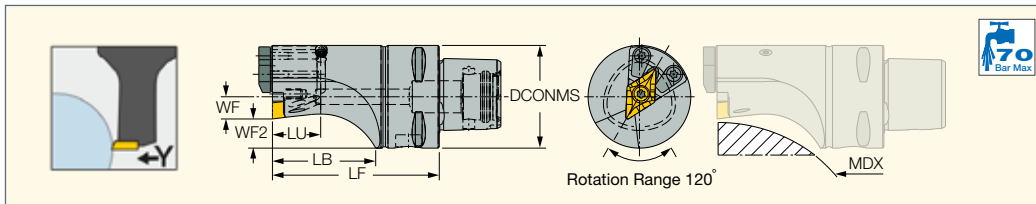

Designation	DCONMS	LU	LB	LF	WF	WF2	MDX ⁽¹⁾	MIID ⁽²⁾	CDI ⁽³⁾
C4-SDJCN-13-SL-H65-Y	40.00	18.80	40.20	65.00	8.64	11.4	120.00	DCMT 13T504-F3P-SL	0
C4-SDJCN-13-SL-H80-Y	40.00	30.30	54.40	80.00	8.64	11.4	210.00	DCMT 13T504-F3P-SL	0
C5-SDJCN-13-SL-H80-Y	50.00	28.20	53.70	80.00	10.76	14.2	180.00	DCMT 13T504-F3P-SL	0
C5-SDJCN-13-SL-H100-Y	50.00	48.20	73.70	100.00	10.76	14.2	320.00	DCMT 13T504-F3P-SL	0
C6-SDJCN-13-SL-H100-Y	63.00	46.80	73.80	100.00	13.44	18.1	260.00	DCMT 13T504-F3P-SL	0
C6-SDJCN-13-SL-H125-Y	63.00	71.30	98.30	125.00	13.44	18.1	420.00	DCMT 13T504-F3P-SL	0

⁽¹⁾ Machinable diameter maximum

⁽²⁾ Master insert identification

⁽³⁾ 1 - Hole for data chip, 0 - Without hole for data chip

Spare Parts

Designation					
C#-SDJCN-13-Y	CH-1.9D-JHP-A SET	BLD IP15/S7	SW6-T-SH	SR M4X4 DIN913 TL360	SR M4X0.7-L9.6 IP15

AVC-SDJCN-Y

Y-Axis Interchangeable Heads
Carrying 55° Rhombic Inserts

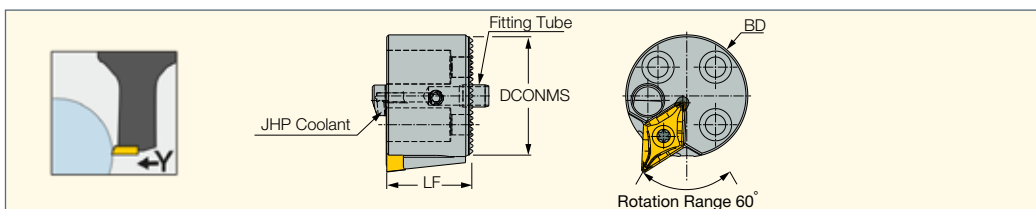

Designation	DCONMS	BD	LF	MIID ⁽¹⁾	CSP ⁽²⁾
AVC-D25-SDJCN-13-SL-Y	25.00	26.00	20.00	DCMT 13T504-F3P-SL	1
AVC-D32-SDJCN-13-SL-Y	32.00	33.00	23.00	DCMT 13T504-F3P-SL	1
AVC-D40-SDJCN-13-SL-Y	40.00	41.00	25.00	DCMT 13T504-F3P-SL	1

⁽¹⁾ Master insert identification

⁽²⁾ 0 - Without coolant supply, 1 - With coolant supply

Spare Parts

Designation						
AVC-SDJCN-Y	CH-1.9D-JHP-A SET	SR M5X5 DIN913 TL360	BLD IP15/S7	SW6-T-SH	SR M4X0.7-L9.6 IP15	PIN FT39 D6-5X11

HSK A63WH-RCMT-Y

Y-Axis Turning Tools
Carrying Round Inserts with
7° Clearance Angle

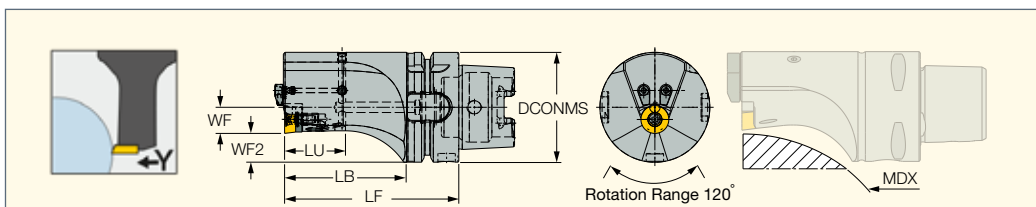

Designation	DCONMS	LU	LB	LF	WF	WF2	MDX ⁽¹⁾	Insert	CDI ⁽²⁾
HSK A63WH-SRDCN-16-100Y	63.00	34.90	69.80	100.00	15.00	16.5	240.00	RCMT 1606MO-14	0
HSK A63WH-SRDCN-16-125Y	63.00	60.00	93.40	125.00	15.00	16.5	380.00	RCMT 1606MO-14	0

• A cooling tube must be used with all coolant through HSK spindles (should be ordered separately).

⁽¹⁾ Machinable diameter maximum

⁽²⁾ 1 - Hole for data chip, 0 - Without hole for data chip

Spare Parts

Designation							
HSK A63WH-RCMT-Y	TRC 5-0	SR TC-4	CH-1.9D-JHP-A SET	SR 16-212	HW 3.0	BLD T20/S7	SW6-T-SH

C#-RCMT-16-Y

Y-Axis Turning Tools
Carrying Round Inserts
with 7° Clearance Angle

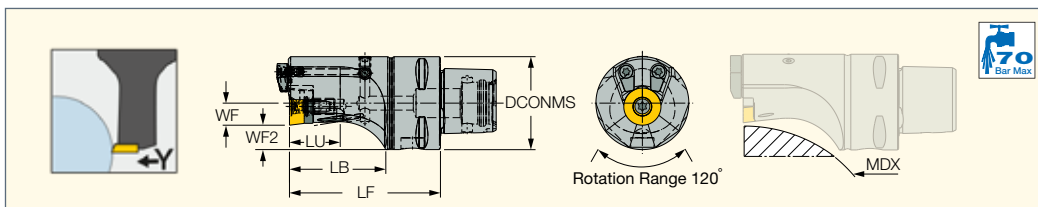

Designation	DCONMS	LU	LB	LF	WF	WF2	MDX ⁽¹⁾	Insert	CDI ⁽²⁾
C4-SRDCN-16-H65-Y	40.00	21.90	41.50	65.00	9.50	10.5	130.00	RCMT 1606M0-14	0
C4-SRDCN-16-H80-Y	40.00	36.80	56.70	80.00	9.50	10.5	210.00	RCMT 1606M0-14	0
C5-SRDCN-16-H80-Y	50.00	27.00	56.20	80.00	12.00	13.0	180.00	RCMT 1606M0-14	0
C5-SRDCN-16-H100-Y	50.00	44.40	76.20	100.00	12.00	13.0	350.00	RCMT 1606M0-14	0
C6-SRDCN-16-H100-Y	63.00	40.50	74.00	100.00	15.00	16.5	260.00	RCMT 1606M0-14	0
C6-SRDCN-16-H125-Y	63.00	65.50	98.90	125.00	15.00	16.5	450.00	RCMT 1606M0-14	0

⁽¹⁾ Machinable diameter maximum

⁽²⁾ 1 - Hole for data chip, 0 - Without hole for data chip

Spare Parts

Designation							
C#-RCMT-16-Y	TRC 5-0	SR TC-4	CH-1.9D-JHP-A SET	SR 16-212	HW 3.0	BLD T20/S7	SW6-T-SH

AVC-SRDCN-Y

Y-Axis Interchangeable Heads
Carrying Round Inserts

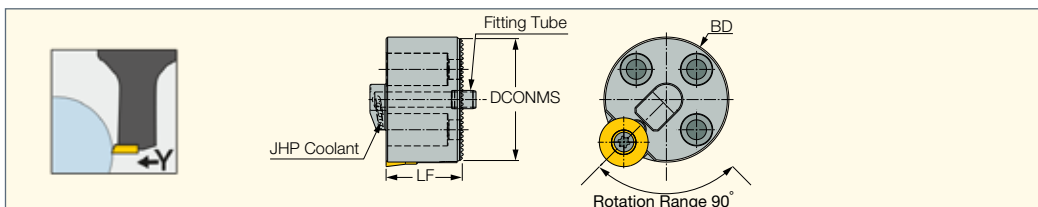

Designation	DCONMS	BD	LF	MID ⁽¹⁾	CSP ⁽²⁾
AVC-D16-SRDCN-08-Y	16.00	17.00	12.00	RCMT 0803M0-14	1
AVC-D20-SRDCN-10-Y	20.00	21.00	20.00	RCMT 10T3M0-14	1
AVC-D25-SRDCN-12-Y	25.00	26.00	20.00	RCMT 1204M0-14	1
AVC-D32-SRDCN-16-Y	32.00	33.00	23.00	RCMT 1606M0-14	1
AVC-D40-SRDCN-16-Y	40.00	41.00	25.00	RCMT 1606M0-14	1

⁽¹⁾ Master insert identification

⁽²⁾ 0 - Without coolant supply, 1 - With coolant supply





70° Corner Angle Turning

NEOTURN
ISOTURNING

New XNMG **70° Corner Insert** for Turning Combines 55° and 80° Inserts. One Insert for **All Turning Applications.**

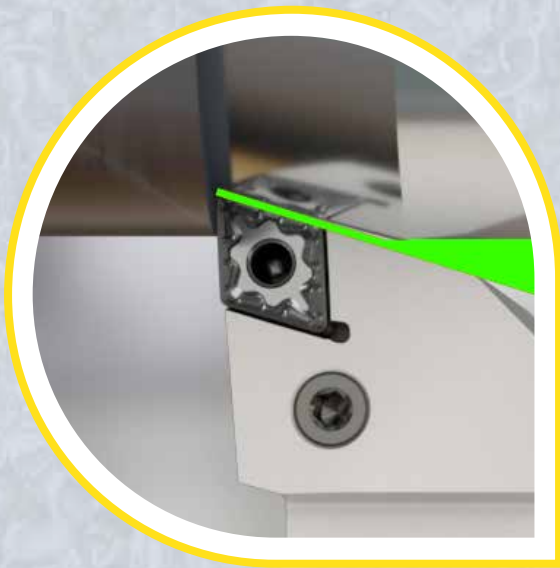

Deeper
Rampdown
and Increased
Flexibility

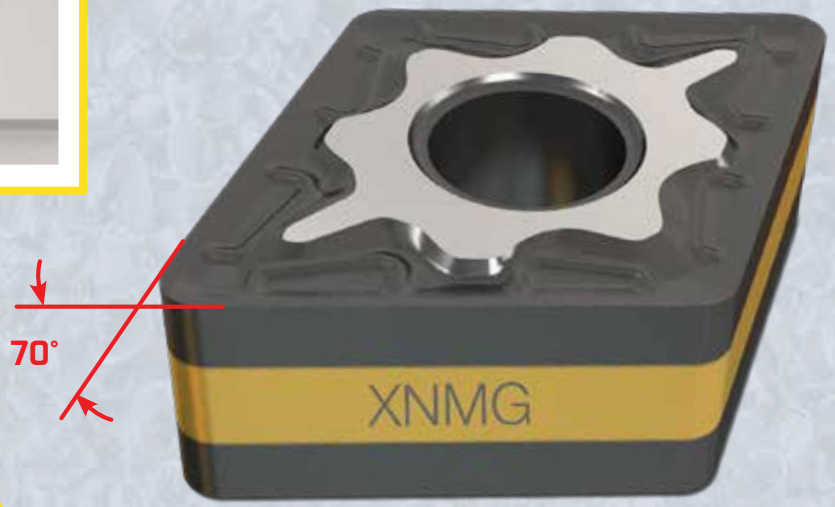

Guaranteed Excellent
Chip Evacuation



ISOTURN

XNMG-F3P

Double-Sided 70° Rhombic Inserts for Semi-Finishing and Finishing Applications

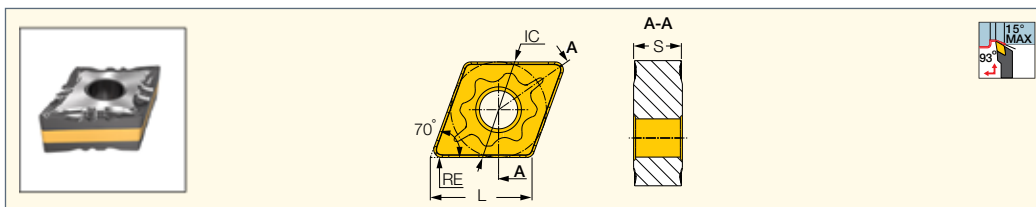

Designation	Dimensions				Tough ↔ Hard				Recommended Machining Data	
	L	IC	S	RE	IC880	IC8250	IC8150	IC807	a _p (mm)	f (mm/rev)
XNMG 090404-F3P	10.14	9.53	4.76	0.40	●	●	●	●	0.50-3.50	0.07-0.25
XNMG 090408-F3P	10.14	9.53	4.76	0.80	●	●	●	●	0.90-3.50	0.08-0.25
XNMG 120404-F3P	13.52	12.70	4.76	0.40	●	●	●	●	0.50-3.50	0.07-0.25
XNMG 120408-F3P	13.52	12.70	4.76	0.80	●	●	●	●	0.90-3.50	0.08-0.25

ISOTURN

XNMG-M3P

Double-Sided 70° Rhombic Inserts for Medium Machining Conditions on Steel

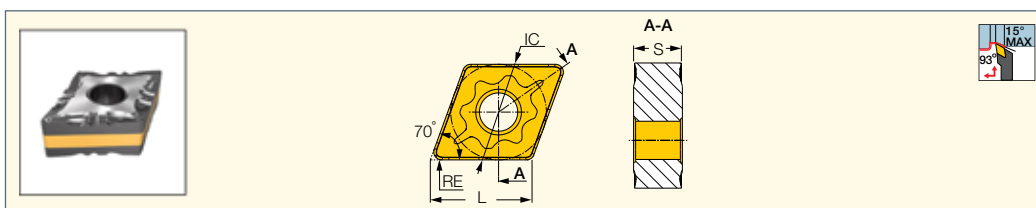

Designation	Dimensions				Tough ↔ Hard				Recommended Machining Data	
	L	IC	S	RE	IC880	IC8250	IC8150	IC807	a _p (mm)	f (mm/rev)
XNMG 090404-M3P	10.14	9.53	4.76	0.40	●	●	●	●	0.50-3.50	0.07-0.25
XNMG 090408-M3P	10.14	9.53	4.76	0.80	●	●	●	●	0.90-3.50	0.08-0.25
XNMG 120404-M3P	13.52	12.70	4.76	0.40	●	●	●	●	0.50-3.50	0.07-0.25
XNMG 120408-M3P	13.52	12.70	4.76	0.80	●	●	●	●	0.90-3.50	0.08-0.25



ISOTURN

XNMG-F3M

Double-sided 70° Rhombic Inserts for Stainless Steel Finishing Applications

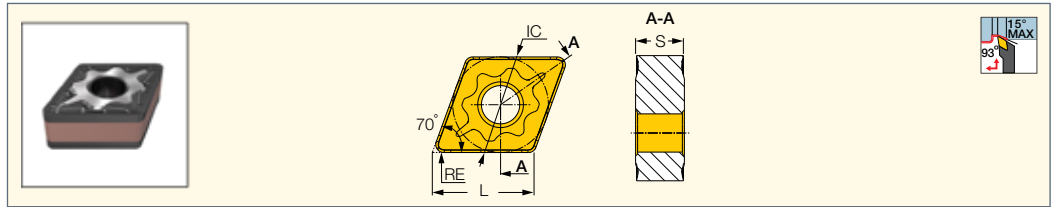

Designation	Dimensions				Tough ↔ Hard					Recommended Machining Data	
	L	IC	S	RE	IC830	IC6025	IC6015	IC806	IC807	a _p (mm)	f (mm/rev)
XNMG 090404-F3M	10.14	9.53	4.76	0.40	●	●	●	●	●	0.10-1.50	0.05-0.30
XNMG 090408-F3M	10.14	9.53	4.76	0.80	●	●	●	●	●	0.10-1.50	0.10-0.40
XNMG 120404-F3M	13.52	12.70	4.76	0.40	●	●	●	●	●	0.10-1.50	0.05-0.30
XNMG 120408-F3M	13.52	12.70	4.76	0.80	●	●	●	●	●	0.10-1.50	0.10-0.40

ISOTURN

XNMG-M3M

Double-Sided 70° Rhombic Inserts for Machining Stainless and Low Carbon Steel

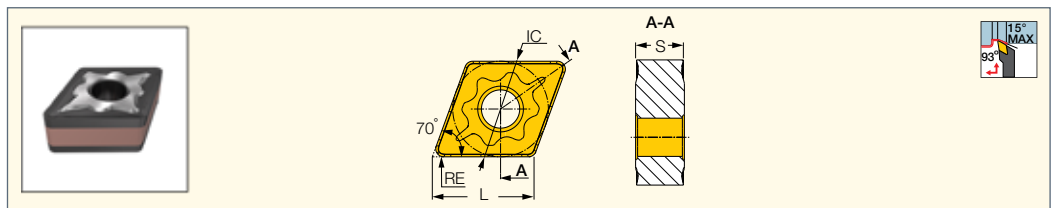

Designation	Dimensions				Tough ↔ Hard					Recommended Machining Data	
	L	IC	S	RE	IC830	IC6025	IC6015	IC806	IC807	a _p (mm)	f (mm/rev)
XNMG 090404-M3M	10.14	9.53	4.76	0.40	●	●	●	●	●	0.40-4.00	0.12-0.40
XNMG 090408-M3M	10.14	9.53	4.76	0.80	●	●	●	●	●	0.50-4.50	0.15-0.50
XNMG 120404-M3M	13.52	12.70	4.76	0.40	●	●	●	●	●	0.50-5.00	0.15-0.50
XNMG 120408-M3M	13.52	12.70	4.76	0.80	●	●	●	●	●	0.50-5.00	0.15-0.50

ISOTURN

DXJNR/L-X-JHP-MC

Rigid Clamp Tools with Channels for High-Pressure Coolant Carrying 70° Rhombic Inserts

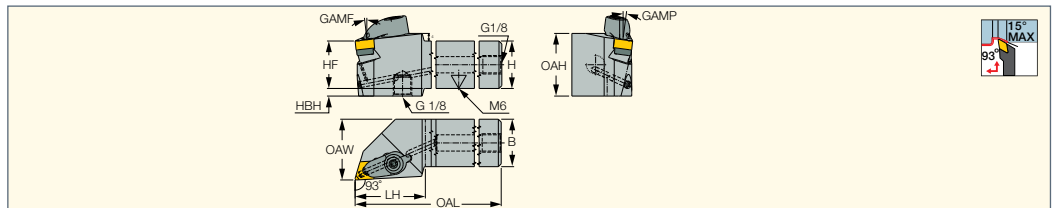

Designation	H	HF	HBH	LH	OAW	OAH	B	OAL	GAMP	GAMF	Insert
DXJNR/L 2020X-09-JHP-MC	20.0	20.0	4.0	37.0	25.00	33.00	20.0	107.00	6.0	6.0	XNMG 0904
DXJNR/L 2525X-09-JHP-MC	25.0	25.0	9.0	37.0	32.00	33.00	25.0	122.00	6.0	6.0	XNMG 0904
DXJNR/L 2020X-12-JHP-MC	20.0	20.0	4.0	37.0	25.00	33.00	20.0	107.00	6.0	6.0	XNMG 1204
DXJNR/L 2525X-12-JHP-MC	25.0	25.0	4.0	37.0	32.00	33.00	25.0	122.00	6.0	6.0	XNMG 1204
DXJNR/L 3232X-12-JHP-MC	32.0	32.0	0.0	37.0	40.00	33.00	32.0	137.00	6.0	6.0	XNMG 1204





High Feed Parting, No Vibrations!

LOGIQ FGRIP
HIGH FEED GRIP HOLDER

Revolutionary Quad Blade and Unique Holder **Enables Deeper Parting with High Feed Rates.** Guaranteed Vibration - Free Parting, High Part Straightness, and Improved Surface Finish Lead to Material Savings. A 160 mm Bar Diameter Can be Cut with a 3 mm Insert.



300% Increased Productivity

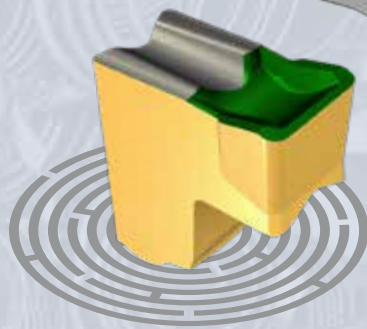

TANG-GRIP
PARTING LINE

New Insert Designed for **High Feed** Parting

D82

D160

VIDEO



VIDEO



A 160 mm Bar Diameter Can be Cut with a 3 mm Insert

TGAQ-JHP

Parting and Grooving Square Adapters with Internal Coolant Holes Carrying TANG-GRIP Tangentially Clamped Inserts

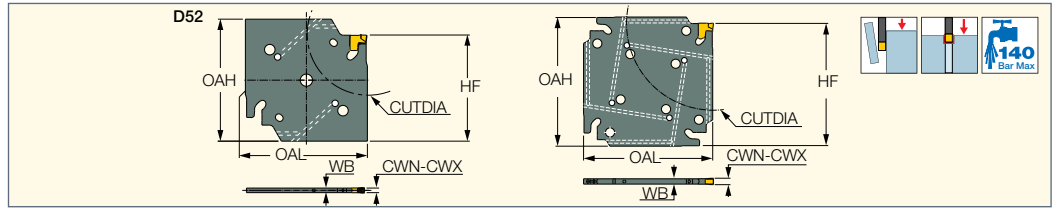

Designation	OAL	OAH	CWN ⁽¹⁾	CWX ⁽²⁾	WB	HF	CUTDIA ⁽³⁾	MIID ⁽⁴⁾	CSP ⁽⁵⁾
TGAQ D52-2-2Z-JHP	50.00	50.00	1.80	2.50	1.65	43.5	52.0	TAG 2	1
TGAQ D52-3-2Z-JHP	50.00	50.00	2.80	3.50	2.50	43.5	52.0	TAG 3	1
TGAQ D52-4-2Z-JHP	50.00	50.00	3.70	4.50	3.40	43.5	52.0	TAG 4	1
TGAQ D82-2-4Z-JHP	61.00	61.00	1.80	2.50	1.65	58.0	82.0	TAG 2	1
TGAQ D82-3-4Z-JHP	61.00	61.00	2.80	3.50	2.50	58.0	82.0	TAG 3	1
TGAQ D82-4-4Z-JHP	61.00	61.00	3.70	4.50	3.40	58.0	82.0	TAG 4	1
TGAQ D120-3-4Z-JHP	90.50	90.50	2.80	3.50	2.50	84.0	120.0	TAG 3	1
TGAQ D120-4-4Z-JHP	90.50	90.50	3.70	4.50	3.40	84.0	120.0	TAG 4	1
TGAQ D120-5-4Z-JHP	90.50	90.50	4.70	5.50	4.00	84.0	120.0	TAG 5	1
TGAQ D160-3-4Z-JHP	100.00	100.00	2.80	3.50	2.50	97.0	160.0	TAG 3	1
TGAQ D160-4-4Z-JHP	100.00	100.00	3.70	4.50	3.40	97.0	160.0	TAG 4	1
TGAQ D160-5-4Z-JHP	100.00	100.00	4.70	5.50	4.00	97.0	160.0	TAG 5	1

• Suitable for all TANG-GRIP inserts

⁽¹⁾ Minimum cutting width

⁽²⁾ Maximum cutting width

⁽³⁾ Maximum diameter for parting

⁽⁴⁾ Master insert identification

⁽⁵⁾ 0 - Without coolant supply, 1 - With coolant supply

Flow Rate vs. Pressure

Designation	70 Bar	100 Bar	140 Bar
	Flow Rate (liters/min)	Flow Rate (liters/min)	Flow Rate (liters/min)
TGAQ D.../-2.../-3...-JHP	4-7	5-8	6-9
TGAQ D.../-4.../-5...-JHP	6-7	7-8	8-9

Spare Parts

Designation			
TGAQ D52-2-2Z-JHP	SR M4X9-SEAL-JHP	JHP COPPER SEAL 1/8"	ETG 2"
TGAQ D52-3-2Z-JHP	SR M4X9-SEAL-JHP	JHP COPPER SEAL 1/8"	ETG 3-4-SH*
TGAQ D52-4-2Z-JHP	SR M4X9-SEAL-JHP	JHP COPPER SEAL 1/8"	ETG 3-4-SH*
TGAQ D82-2-4Z-JHP	SR M4X9-SEAL-JHP	JHP COPPER SEAL 1/8"	ETG 2"
TGAQ D82-3-4Z-JHP	SR M4X9-SEAL-JHP	JHP COPPER SEAL 1/8"	ETG 3-4-SH*
TGAQ D82-4-4Z-JHP	SR M4X9-SEAL-JHP	JHP COPPER SEAL 1/8"	ETG 3-4-SH*
TGAQ D120-3-4Z-JHP	SR M4X9-SEAL-JHP	JHP COPPER SEAL 1/8"	ETG 3-4-SH*
TGAQ D120-4-4Z-JHP	SR M4X9-SEAL-JHP	JHP COPPER SEAL 1/8"	ETG 3-4-SH*
TGAQ D120-5-4Z-JHP	SR M4X9-SEAL-JHP	JHP COPPER SEAL 1/8"	ETG 5-7*
TGAQ D160-3-4Z-JHP	SR M4X9-SEAL-JHP	JHP COPPER SEAL 1/8"	ETG 3-4-SH*
TGAQ D160-4-4Z-JHP	SR M4X9-SEAL-JHP	JHP COPPER SEAL 1/8"	ETG 3-4-SH*
TGAQ D160-5-4Z-JHP	SR M4X9-SEAL-JHP	JHP COPPER SEAL 1/8"	ETG 5-7*

* Optional, should be ordered separately

TGAQ
Parting and Grooving Square
Adapters Carrying TANG-GRIP
Tangentially Clamped Inserts

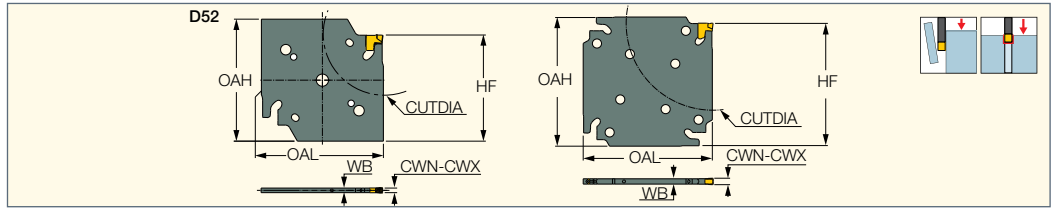



Designation	OAL	OAH	CWN ⁽¹⁾	CWX ⁽²⁾	WB	HF	CUTDIA ⁽³⁾	MIID ⁽⁴⁾	CSP ⁽⁵⁾
TGAQ D52-2-2Z	50.00	50.00	1.80	2.50	1.65	43.5	52.0	TAG 2	0
TGAQ D52-3-2Z	50.00	50.00	2.80	3.50	2.50	43.5	52.0	TAG 3	0
TGAQ D52-4-2Z	50.00	50.00	3.70	4.50	3.40	43.5	52.0	TAG 4	0
TGAQ D82-2-4Z	61.00	61.00	1.80	2.50	1.65	58.0	82.0	TAG 2	0
TGAQ D82-3-4Z	61.00	61.00	2.80	3.50	2.50	58.0	82.0	TAG 3	0
TGAQ D82-4-4Z	61.00	61.00	3.70	4.50	3.40	58.0	82.0	TAG 4	0
TGAQ D120-3-4Z	90.50	90.50	2.80	3.50	2.50	84.0	120.0	TAG 3	0
TGAQ D120-4-4Z	90.50	90.50	3.70	4.50	3.40	84.0	120.0	TAG 4	0
TGAQ D120-5-4Z	90.50	90.50	4.70	5.50	4.00	84.0	120.0	TAG 5	0
TGAQ D160-3-4Z	100.00	100.00	2.80	3.50	2.50	97.0	160.0	TAG 3	0
TGAQ D160-4-4Z	100.00	100.00	3.70	4.50	3.40	97.0	160.0	TAG 4	0
TGAQ D160-5-4Z	100.00	100.00	4.70	5.50	4.00	97.0	160.0	TAG 5	0

• Suitable for all TANG-GRIP inserts

- (1) Minimum cutting width
- (2) Maximum cutting width
- (3) Maximum diameter for parting
- (4) Master insert identification
- (5) 0 - Without coolant supply, 1 - With coolant supply

Spare Parts

Designation		
TGAQ D52-2-2Z	SR ISO 14580 M4X10	ETG 2*
TGAQ D52-3-2Z	SR ISO 14580 M4X10	ETG 3-4-SH*
TGAQ D52-4-2Z	SR ISO 14580 M4X10	ETG 3-4-SH*
TGAQ D82-2-4Z	SR ISO 14580 M4X10	ETG 2*
TGAQ D82-3-4Z	SR ISO 14580 M4X10	ETG 3-4-SH*
TGAQ D82-4-4Z	SR ISO 14580 M4X10	ETG 3-4-SH*
TGAQ D120-3-4Z	SR ISO 14580 M4X10	ETG 3-4-SH*
TGAQ D120-4-4Z	SR ISO 14580 M4X10	ETG 3-4-SH*
TGAQ D120-5-4Z	SR ISO 14580 M4X10	ETG 5-7*
TGAQ D160-3-4Z	SR ISO 14580 M4X10	ETG 3-4-SH*
TGAQ D160-4-4Z	SR ISO 14580 M4X10	ETG 3-4-SH*
TGAQ D160-5-4Z	SR ISO 14580 M4X10	ETG 5-7*

* Optional, should be ordered separately



TGTBQ-JHP
Tool Blocks for Square
TANG-F-GRIP and DO-F-GRIP
Parting and Grooving Adapters
for High-Pressure Coolant

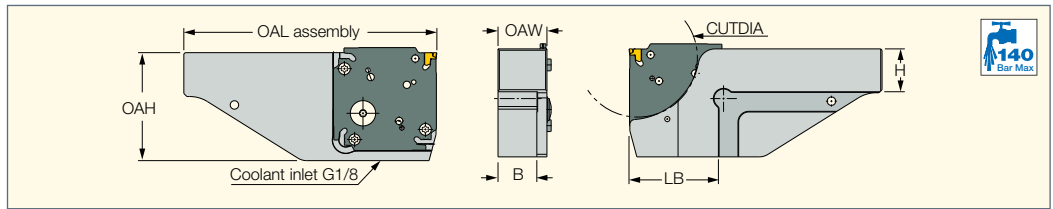

Designation	OAH	H	B	OAW	OAL	LB	CUTDIA
TGTBQ 20L-D52-JHP	50.00	20.0	20.5	26.50	122.00	34.00	52.0
TGTBQ 20R-D52-JHP	50.00	20.0	20.5	26.50	122.00	34.00	52.0
TGTBQ 25L-D52-JHP	50.00	25.0	25.5	31.50	132.00	34.00	52.0
TGTBQ 25R-D52-JHP	50.00	25.0	25.5	31.50	132.00	34.00	52.0
TGTBQ 20L-D82-JHP	64.00	20.0	20.5	26.50	140.00	53.00	82.0
TGTBQ 20R-D82-JHP	64.00	20.0	20.5	26.50	140.00	53.00	82.0
TGTBQ 25L-D82-JHP	64.00	25.0	25.5	31.50	150.00	53.00	82.0
TGTBQ 25R-D82-JHP	64.00	25.0	25.5	31.50	150.00	53.00	82.0
TGTBQ 32L-D82-JHP	64.00	32.0	32.5	38.50	150.50	53.50	82.0
TGTBQ 32R-D82-JHP	64.00	32.0	32.5	38.50	150.50	53.50	82.0
TGTBQ 25L-D120-JHP	95.00	25.0	25.5	31.50	165.00	67.00	120.0
TGTBQ 25R-D120-JHP	95.00	25.0	25.5	31.50	165.00	67.00	120.0
TGTBQ 32L-D120-JHP	95.00	32.0	32.5	38.50	165.00	67.00	120.0
TGTBQ 32R-D120-JHP	95.00	32.0	32.5	38.50	165.00	67.00	120.0
TGTBQ 25L-D160-JHP	107.00	25.0	25.5	31.50	190.50	92.50	160.0
TGTBQ 25R-D160-JHP	107.00	25.0	25.5	31.50	190.50	92.50	160.0
TGTBQ 32L-D160-JHP	107.00	32.0	32.5	38.50	190.50	92.50	160.0
TGTBQ 32R-D160-JHP	107.00	32.0	32.5	38.50	190.50	92.50	160.0
TGTBQ 40L-D160-JHP	107.00	40.0	40.5	46.50	190.50	92.50	160.0
TGTBQ 40R-D160-JHP	107.00	40.0	40.5	46.50	190.50	92.50	160.0

Table determining depth of cut for grooving as function of workpiece diameter

Designation	øDmax																	
	53	54	55	56	57	59	61	64	67	71	75	81	88	96	107	122	141	169
TGTBQ...D52-JHP	53	54	55	56	57	59	61	64	67	71	75	81	88	96	107	122	141	169
TGTBQ...D82-JHP	107	110	114	119	124	130	137	145	154	165	178	194	213	237	267	308	363	443
TGTBQ...D120-JHP	202	210	219	229	240	253	267	283	302	324	349	380	417	462	518	592	689	827
TGTBQ...D160-JHP	345	361	377	396	418	441	468	499	534	576	624	682	753	840	951	1096	1294	1583
CDX	21	20	19	18	17	16	15	14	13	12	11	10	9	8	7	6	5	4

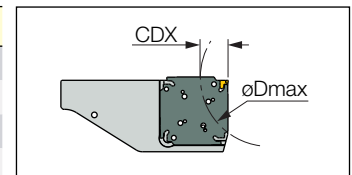

Designation	øDmax															
	83	83	84	84	85	86	87	88	89	91	92	94	96	98	101	103
TGTBQ...D82-JHP	83	83	84	84	85	86	87	88	89	91	92	94	96	98	101	103
TGTBQ...D120-JHP	139	141	143	145	148	150	153	156	160	164	168	172	177	183	188	195
TGTBQ...D160-JHP	220	225	229	234	239	245	251	257	264	271	279	288	298	308	320	332
CDX	37	36	35	34	33	32	31	30	29	28	27	26	25	24	23	22

Designation	øDmax																
	121	122	123	123	124	125	125	126	127	128	129	130	131	132	134	135	137
TGTBQ...D120-JHP	121	122	123	123	124	125	125	126	127	128	129	130	131	132	134	135	137
TGTBQ...D160-JHP	171	177	181	183	184	186	188	190	193	195	198	200	203	206	209	213	217
CDX	56-60	53-55	52	51	50	49	48	47	46	45	44	43	42	41	40	39	38

1. **Block:** TGTBQ...D...
2. **Blade:** T/DGAQ...
3. **Locating Pin:** Side thrust Pin 3mm
4. **Screw:** SR M4x10 ISO 14580
5. **Screw:** SR M4x9-Seal-JHP
6. **Seal washer:** CSW 1/8"
7. **O-ring:** O-ring 10x2 NBR

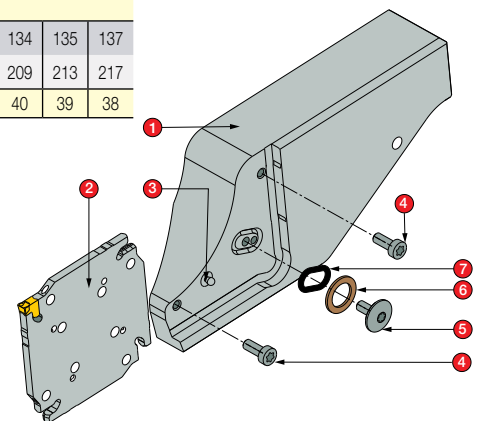

Spare Parts

Designation							
TGTBQ-JHP	SR M4X9-SEAL-JHP	SIDE THRUST PIN 3mm	JHP COPPER SEAL 1/8"	SR ISO 14580 M4X10	SW6-SD	BLD T20/S7	O-RING 10X2 NBR

TGTBQ-JHP-MC
Tool Blocks for Parting and Grooving Square Adapters for High-Pressure Coolant with Three Cooling Inlets

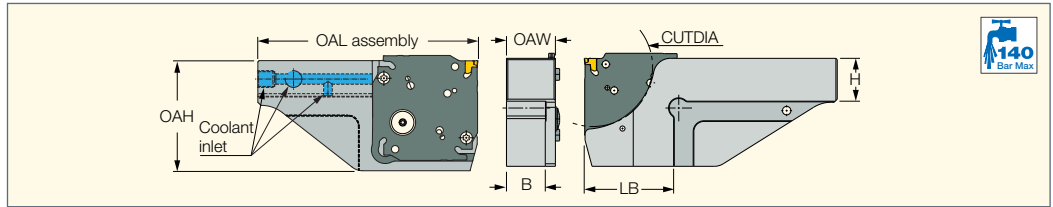

Designation	OAH	H	B	OAW	OAL	LB	CUTDIA
TGTBQ 20R/L-D52-JHP-MC	50.00	20.0	20.5	26.50	112.00	42.00	52.0
TGTBQ 25R/L-D52-JHP-MC	50.00	25.0	26.5	31.50	125.00	40.00	52.0
TGTBQ 20R/L-D82-JHP-MC	64.00	20.0	20.5	26.50	127.50	57.50	82.0
TGTBQ 25R/L-D82-JHP-MC	64.00	25.0	26.5	31.50	142.50	57.50	82.0
TGTBQ 25R/L-D120-JHP-MC	95.00	25.0	26.5	31.50	158.00	73.00	120.0

Spare Parts

Designation								
TGTBQ-JHP-MC	SR M4X9-SEAL-JHP	SIDE THRUST PIN 3mm	JHP COPPER SEAL 1/8"	SR ISO 14580 M4X10	BLD T20/S7	SW6-SD	O-RING 10X2 NBR	PLG G1/8 TL360



DGAQ-JHP

Parting and Grooving Square Adapters with Internal Coolant Holes Carrying DO-GRIP Inserts

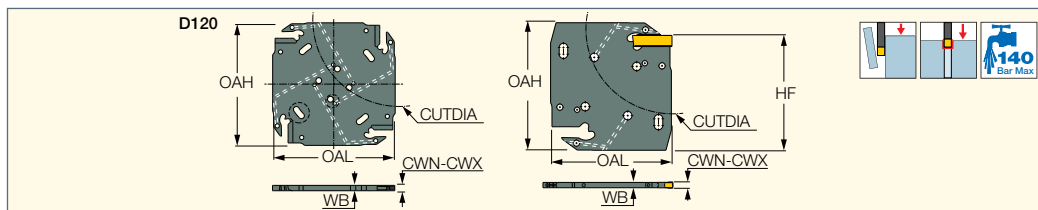

Designation	OAL	OAH	CWN ⁽¹⁾	CWX ⁽²⁾	WB	HF	CUTDIA ⁽³⁾	MIID ⁽⁴⁾	CSP ⁽⁵⁾
DGAQ D52-2-2Z-JHP	50.00	50.00	1.90	2.50	1.72	43.5	52.0	DGN 2	1
DGAQ D52-3-2Z-JHP	50.00	50.00	3.00	3.18	2.50	43.5	52.0	DGN 3	1
DGAQ D52-4-2Z-JHP	50.00	50.00	4.00	4.00	3.20	43.5	52.0	DGN 4	1
DGAQ D82-3-2Z-JHP	64.40	64.40	3.00	3.18	2.50	58.0	82.0	DGN 3	1
DGAQ D82-4-2Z-JHP	64.40	64.40	4.00	4.00	3.20	58.0	82.0	DGN 4	1
DGAQ D82-5-2Z-JHP	64.40	64.40	5.00	5.00	4.00	58.0	82.0	DGN 5	1
DGAQ D120-4-4Z-JHP	90.50	90.50	4.00	4.00	3.20	84.0	120.0	DGN 4	1
DGAQ D120-5-4Z-JHP	90.50	90.50	5.00	5.00	4.00	84.0	120.0	DGN 5	1

• When using 2 and 3mm double-sided inserts, the depth of cut is limited up to 19mm. For larger depth, use a DGNM type single-ended insert.

- (1) Minimum cutting width
- (2) Maximum cutting width
- (3) Maximum diameter for parting
- (4) Master insert identification
- (5) 0 - Without coolant supply, 1 - With coolant supply

Flow Rate vs. Pressure

Designation	70 Bar Flow Rate (liters/min)	100 Bar Flow Rate (liters/min)	140 Bar Flow Rate (liters/min)
DGAQ D.../-2/-3...-JHP	4-7	5-8	6-9
DGAQ D.../-4/-5...-JHP	6-7	7-8	8-9

Spare Parts

Designation			
DGAQ-JHP	SR M4X9-SEAL-JHP	JHP COPPER SEAL 1/8"	EDG 33A*

* Optional, should be ordered separately

DGAQ

Parting and Grooving Square Adapters Carrying DO-GRIP Inserts

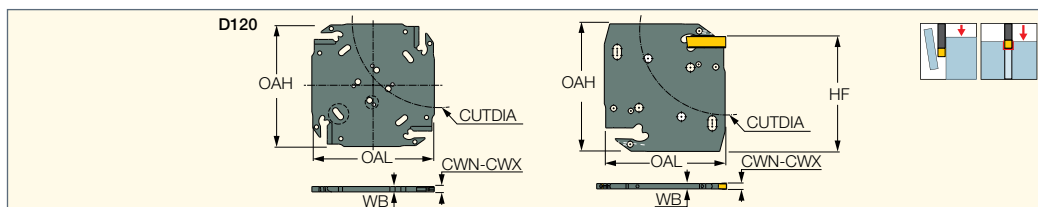

Designation	OAL	OAH	CWN ⁽¹⁾	CWX ⁽²⁾	WB	HF	CUTDIA ⁽³⁾	MIID ⁽⁴⁾	CSP ⁽⁵⁾
DGAQ D52-2-2Z	50.00	50.00	1.90	2.50	1.72	43.5	52.0	DGN 2	0
DGAQ D52-3-2Z	50.00	50.00	3.00	3.18	2.50	43.5	52.0	DGN 3	0
DGAQ D52-4-2Z	50.00	50.00	4.00	4.00	3.20	43.5	52.0	DGN 4	0
DGAQ D82-3-2Z	64.40	64.40	3.00	3.18	2.50	58.0	82.0	DGN 3	0
DGAQ D82-4-2Z	64.40	64.40	4.00	4.00	3.20	58.0	82.0	DGN 4	0
DGAQ D82-5-2Z	64.40	64.40	5.00	5.00	4.00	58.0	82.0	DGN 5	0
DGAQ D120-4-4Z	90.50	90.50	4.00	4.00	3.20	84.0	120.0	DGN 4	0
DGAQ D120-5-4Z	90.50	90.50	5.00	5.00	4.00	84.0	120.0	DGN 5	0

• When using 2 and 3mm double-sided inserts, the depth of cut is limited up to 19mm. For larger depth, use a DGNM type single-ended insert.

- (1) Minimum cutting width
- (2) Maximum cutting width
- (3) Maximum diameter for parting
- (4) Master insert identification
- (5) 0 - Without coolant supply, 1 - With coolant supply

Spare Parts

Designation		
DGAQ	SR ISO 14580 M4X10	EDG 33A*

* Optional, should be ordered separately



Innovative Clamping with Pinpointed Coolant

JETCROWN
LOGIQ JET COOLANT



Quick Clamping Crown

A Unique Method for Clamping a Square-Shaped Blade with **Direct Pinpointed Coolant**.

Improves Insert Life Time.

No Setup Time

Fast Blade Indexing.

Top and Bottom
Highly Efficient
Pinpointed Coolant

200%
More Parting
Profitability



VIDEO



TGTBQ-ECD-JHP (JET-CROWN)
Tool Blocks for Square
TANG-F-GRIP (TGAQ-ECD)
Parting and Grooving Adapters
for High-Pressure Coolant

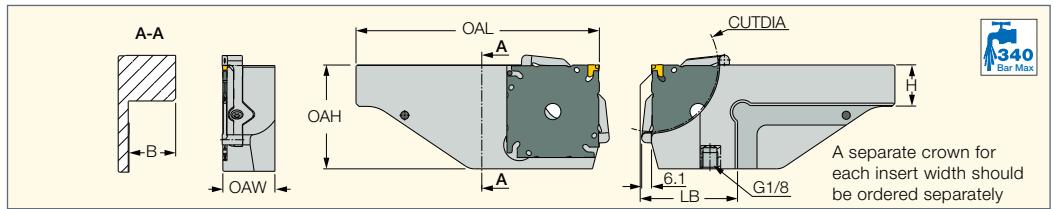

Designation	OAH	H	B	OAW	OAL	LB	CUTDIA
TGTBQ 20L-D65-ECD-JHP	55.00	20.0	20.5	26.50	129.00	42.00	65.0
TGTBQ 20R-D65-ECD-JHP	55.00	20.0	20.5	26.50	129.00	42.00	65.0
TGTBQ 25L-D65-ECD-JHP	55.00	25.0	25.5	31.50	139.00	42.00	65.0
TGTBQ 25R-D65-ECD-JHP	55.00	25.0	25.5	31.50	139.00	42.00	65.0
TGTBQ 20L-D82-ECD-JHP	64.00	20.0	20.5	26.50	140.00	53.00	82.0
TGTBQ 20R-D82-ECD-JHP	64.00	20.0	20.5	26.50	140.00	53.00	82.0
TGTBQ 25L-D82-ECD-JHP	64.00	25.0	25.5	31.50	150.00	53.00	82.0
TGTBQ 25R-D82-ECD-JHP	64.00	25.0	25.5	31.50	150.00	53.00	82.0

• A separate crown for each insert width should be ordered separately.

Depth of cut as function of workpiece diameter

Designation	Dmax																																							
TGTBQ ..R/L-D65-ECD	98	95	90	87	84	81	78	76	74	73	72	70	69	68	67	66	65	8	9	10	11	12	13	14	15	16	17	18	19	20-21	22	23-24	25-33	32.5						
TGTBQ ..R/L-D82-ECD	118	116	112	108	105	102	99	97	95	93	91	90	89	88	87	86	85	84	83	82	11	12	13	14	15	16	17	18	19	20	21	22	23	24	25	26	27	28	31	41
CDX																																								

The tool cannot be used for grooving applications when the workpiece diameter is larger than 118mm.

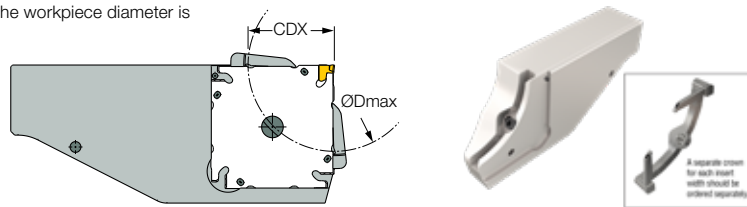

Spare Parts

Designation			
TGTBQ-ECD-JHP (JET-CROWN)	SR M7-R-L	BLD T20/S7	SW6-SD

TGAQ-ECD (JET-CROWN)
Parting and Grooving Square
Adapters Compatible with TANG-GRIP Inserts (Single-Ended)

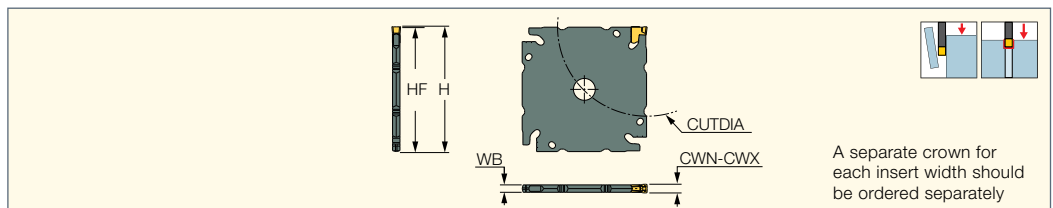

Designation	CWN ⁽¹⁾	CWX ⁽²⁾	WB	H	HF ⁽³⁾	CUTDIA	MIID ⁽⁴⁾
TGAQ D65-2-4Z-ECD	1.80	2.50	1.65	49.0	48.7	65.0	TAG N2
TGAQ D65-3-4Z-ECD	2.80	3.50	2.50	49.0	48.7	65.0	TAG N3
TGAQ D82-2-4Z-ECD	1.80	2.50	1.65	58.0	57.7	82.0	TAG N2
TGAQ D82-3-4Z-ECD	2.80	3.50	2.50	58.0	57.7	82.0	TAG N3
TGAQ D82-4-4Z-ECD	3.70	4.50	3.40	58.0	57.7	82.0	TAG N4

• Suitable for all TANG-GRIP inserts

- (1) Minimum cutting width
- (2) Maximum cutting width
- (3) Related to insert
- (4) Master insert identification

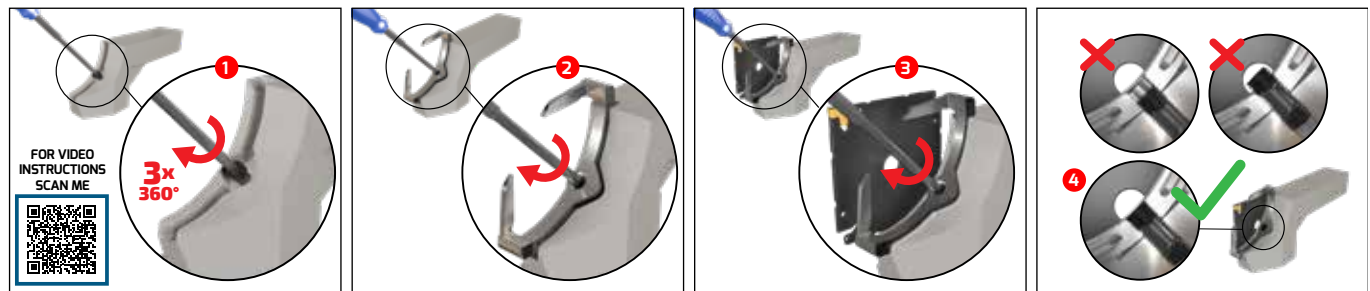

Spare Parts

Designation		
TGAQ D65-2-4Z-ECD	ECD D65-2-TG*	ETG 2*
TGAQ D65-3-4Z-ECD	ECD D65-3-TG*	ETG 3-4-SH*
TGAQ D82-2-4Z-ECD	ECD D82-2-TG*	ETG 2*
TGAQ D82-3-4Z-ECD	ECD D82-3-TG*	ETG 3-4-SH*
TGAQ D82-4-4Z-ECD	ECD D82-4-TG*	ETG 3-4-SH*

* Optional, should be ordered separately



Multi-Task Holder

LOGIQ **FGRIP**
HIGH FEED Y-AXIS

New Intermediate Size Holder for **Y-Axis Parting on Multi-Tasking Machines** Enables Parting at High Feed Rates. **Vibration Free!**



Vibration Free!



Same Holder and Blade
for Y-and X-Axis Parting

VIDEO



TGTBY-JHP

Y-Axis Intermediate Prismatic Holders for Square JHP Adapters on Multi-Task Machines for Parting and Grooving

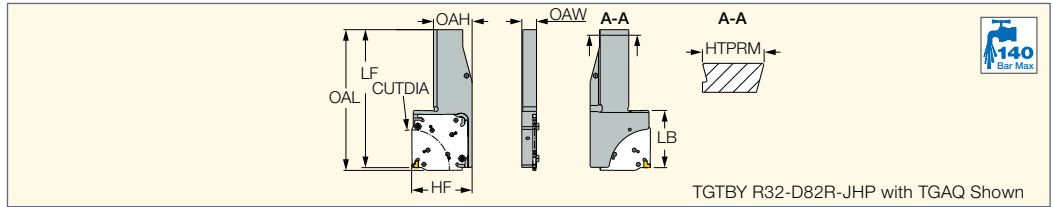

TGTBY R32-D82R-JHP with TGAQ Shown

Designation	OAH	HF	OAW	LF	LB	CUTDIA	OAL ⁽¹⁾	OAL ⁽²⁾	HTPRM
TGTBY R/L32-D82R-JHP	42.00	65.8	16.00	150.00	62.00	CUTDIA	153.00	156.40	32.00
TGTBY R/L32-D82L-JHP	42.00	65.8	16.00	150.00	62.00	82.0	153.00	156.40	32.00

• Can be used also for X-axis (multi-task machines) - location pin should be removed

⁽¹⁾ Overall length with TGAQ adapter

⁽²⁾ Overall length with DGAQ adapter

Y-Axis Tool Setup on Multi-Task Machines

Parting and Setup in Y-Axis Direction

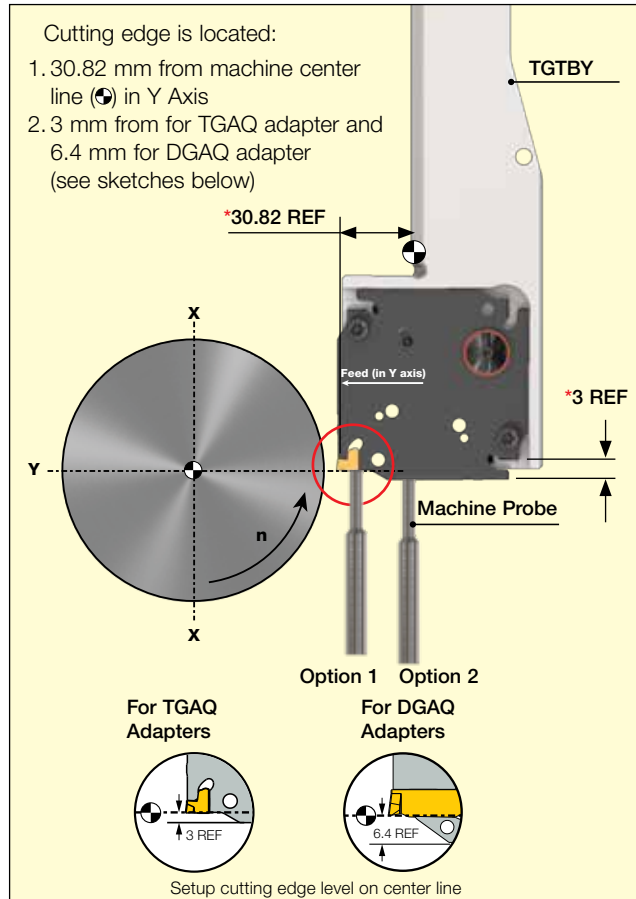

For Y-Axis cut off, compensate 30.82 mm in Y-Axis direction and compensate 3 mm for TGAQ adapters or 6.4 mm for DGAQ adapters in X-Axis direction.

Set the cutting edge on the center line:

Option 1 - Gauge the cutting edge - this is preferable due to better accuracy

Option 2 - Gauge the blade and compensate 3mm / 6.4mm

- Block:** TGTBY
- Locating pin:** Side thrust Pin 3 mm
- Clamping screw :** SR M4x10 ISO 14580
- Clamping & sealing screw:** SR M4x9-Seal-JHP
- Seal washer:** CSW 1/8"
- O-ring:** O-ring 10x2 NBR
- Lower sealing plug:** Plug G1/8-6.5 TL360
- Upper sealing screw:** SR M3x4-DIN913

Spare Parts

Designation									
TGTBY-JHP	SR ISO 14580 M4x10	SR M4x9-SEAL-JHP	OR 16x2 NBR	JHP COPPER SEAL 1/8"	BLD T20/S7	SW6-SD	PLG G1/8 TL360	HW 5.0	SIDE THRUST PIN 3mm

Parting and Setup in X-Axis Direction - Optional

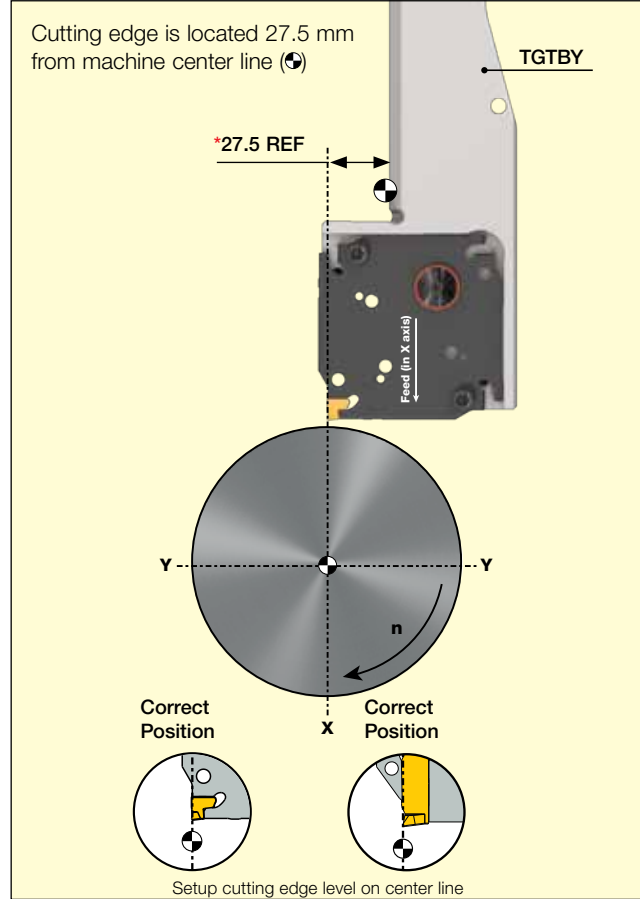

* For X-Axis cut off, compensate 27.5 mm in Y-Axis direction. Location pin should be removed.

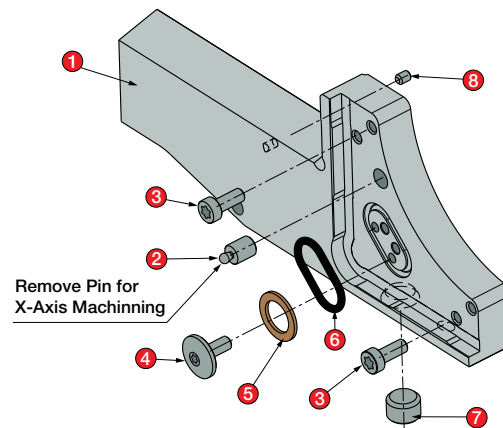



Y-Axis Versatile Parting

TANG-GRIP
Y AXIS PARTING LINE

NEW Modular TANG-GRIP
Adapters for **Y-Axis Parting**
on Multi-Tasking Machines
and Turning Centers.

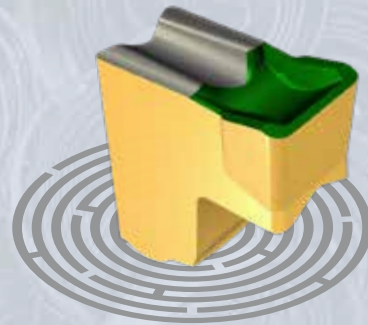

TANG-GRIP
PARTING LINE

New Insert Designed for
High Feed Parting





VIDEO

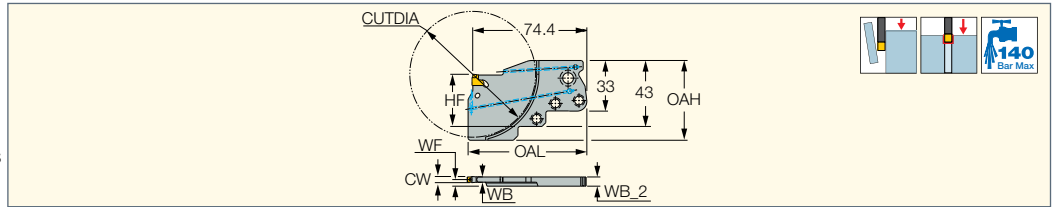

TAGPAD-Y-JHP

Y-Axis Adapters for Parting & Grooving on Multi-Task Machines & Turning Centers with JHP Channels and TANG-GRIP Inserts



Designation	CW	WF	WB	WB_2	OAL	OAH	HF	CUTDIA	MIID ⁽¹⁾	
TAGPAD-Y-D82R/L-3C	3.00	4.80	2.40	6.0	77.40	52.00	34.0	82.0	TAG N3HF	ETG 3-4-SH*
TAGPAD-Y-D82R/L-4C	4.00	4.30	3.40	6.0	77.40	52.00	34.0	82.0	TAG N4HF	ETG 3-4-SH*

• Can be offered for parting up to 125mm diameter as semi standard: TAGPAD-Y-125R/L-3C, TAGPAD-Y-125R/L-4C

• **The tool types shown are currently unavailable in the USA, Canada, China, Japan and Korea.**

⁽¹⁾ Master insert identification

* Optional, should be ordered separately

Y Axis TAGPAD setup on Multi-Task and Turning Center Machines
For setup in X direction, use the dimensions marked on the adapter. Setup in Y Axis is not needed.

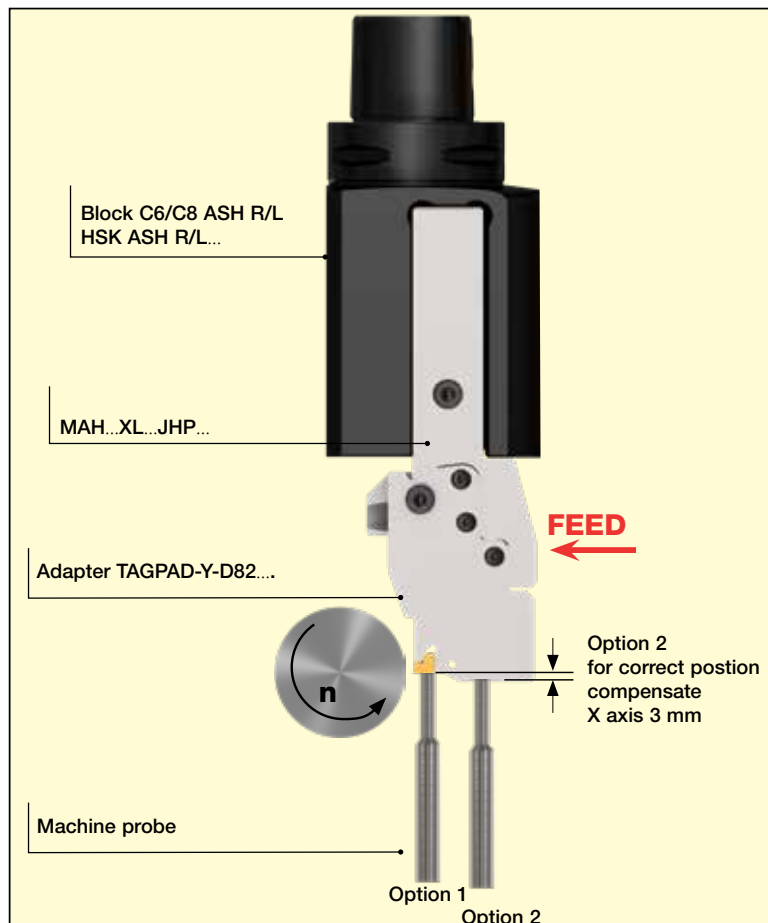
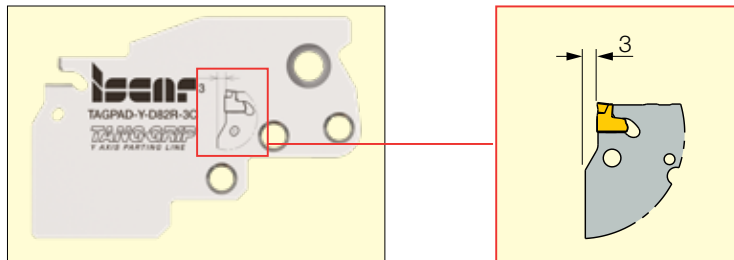

* Option 1 is preferable due to better accuracy

Setting in X Axis

Set the cutting edge on the center line:

Option 1 - Gauge the cutting edge

Option 2 - Gauge the blade and compensate 3mm



Narrow Parting for Cost Savings!

SWISSGRIP
N A R R O W W I D T H S

Innovative Tool Holder with a **2 Pocket Blade** for Parting and Grooving. Narrow Widths of **0.6-1.2 mm**. Fits Swiss-Type Machines. Easy and Fast Blade Indexing with **No Setup Time**.



High Cost Savings
No Setup Time

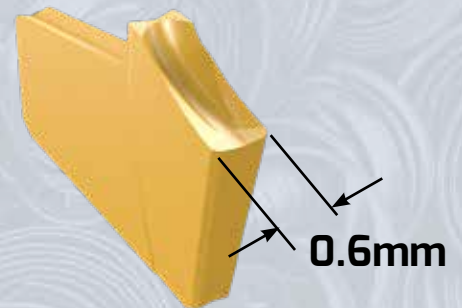

- 0.6 and 0.8 Insert Widths for 10 mm Part Diameter.
 - 1.0 and 1.2 Insert Widths for 16 mm Part Diameter.
- Increments of 0.2 mm**



Easy and Fast Blade Indexing from Either Side of the Tool

VIDEO



THQR/L

Parting and Grooving Holder for a SELF-GRIP Mini Blades (SGAQ), Suitable for Swiss-Type Machines

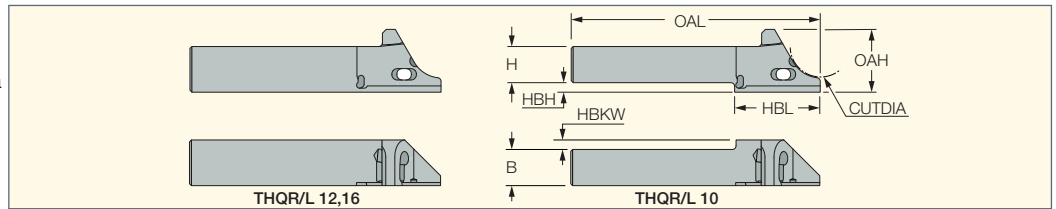

Designation	H	OAL	HF	OAH	HBL	HBH	CUTDIA	HBKW	B
THQR/L 10-D16	10.0	100.00	10.0	16.50	22.6	2.0	16.0	12.00	10.0
THQR/L 12-D16	12.0	100.00	12.0	16.50	-	-	16.0	-	12.0
THQR/L 16-D16	16.0	100.00	16.0	20.50	-	-	16.0	-	16.0

Designation	CW	CUTDIA	f
THQL/R 10-D16 + SGAQ 0.6	0.6	10	9.68
THQL/R 10-D16 + SGAQ 0.8	0.8	10	9.68
THQL/R 12-D16 + SGAQ 0.6	0.6	10	11.68
THQL/R 12-D16 + SGAQ 0.8	0.8	10	11.68
THQL/R 16-D16 + SGAQ 0.6	0.6	10	15.68
THQL/R 16-D16 + SGAQ 0.8	0.8	10	15.68

Designation	CW	CUTDIA	f
THQL/R 10-D16 + SGAQ 1.0	1	16	9.60
THQL/R 10-D16 + SGAQ 1.2	1.2	16	9.68
THQL/R 12-D16 + SGAQ 1.0	1	16	11.60
THQL/R 12-D16 + SGAQ 1.2	1.2	16	11.68
THQL/R 16-D16 + SGAQ 1.0	1	16	15.60
THQL/R 16-D16 + SGAQ 1.2	1.2	16	15.68

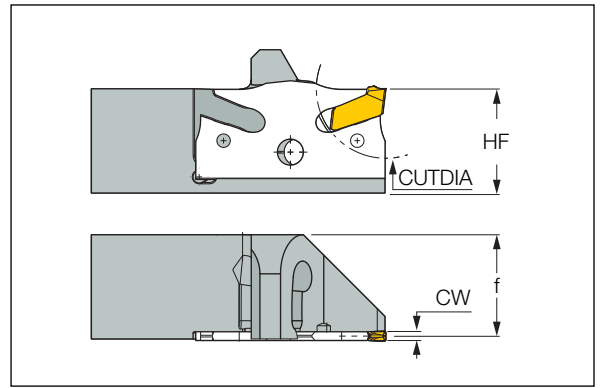



Spare Parts

Designation	
THQR/L	 ESG-SWISS 0.6-1.2

SGAQ

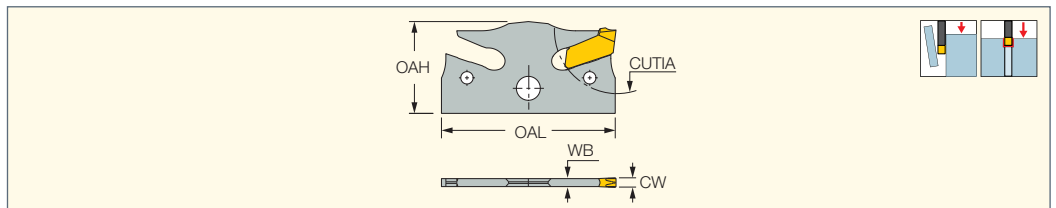
SELF-GRIP Mini Blades for Parting and Grooving, Suitable for Swiss-Type Machines



Designation	OAH	OAL	CUTDIA	WB	CW	MIID ⁽¹⁾	
SGAQ D10-0.6	11.50	21.80	10.0	0.50	0.60	GFT 0.6J-0.1	ESG-SLM*
SGAQ D10-0.8	11.50	21.80	10.0	0.68	0.80	GFT 0.8J-0.1	ESG-SLM*
SGAQ D16-1.0	11.50	21.80	16.0	0.85	1.00	GFT 1.0J-0.1	ESG-SLM*
SGAQ D16-1.2	11.50	21.80	16.0	1.00	1.20	GFT 1.2J-0.14	ESG-SLM*

⁽¹⁾ Master insert identification

* Optional, should be ordered separately

GFT-J

Thin Parting, Grooving and Slitting Single-Ended Inserts for Soft Materials

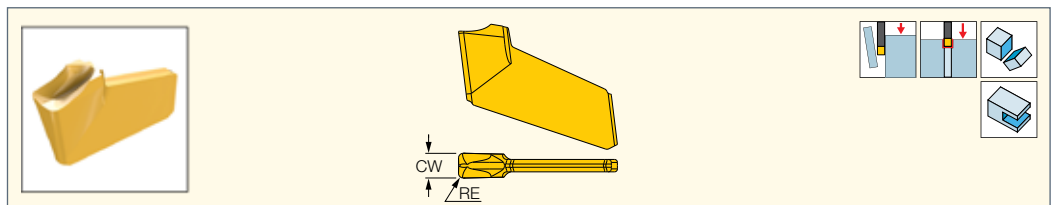

Designation	Dimensions		Tough ↔ Hard		Recommended Machining Data
	CW	RE	IC1028	IC1008	
GFT 0.6J-0.1	0.60	0.10	•	•	f groove (mm/rev) 0.03-0.05
GFT 0.8J-0.1	0.80	0.10	•	•	0.03-0.07
GFT 1.0J-0.1	1.00	0.10	•	•	0.03-0.09
GFT 1.2J-0.14	1.20	0.14	•	•	0.03-0.10





NEOLOGIQ DRILL

MACHINING INTELLIGENTLY



LOGIQ 3CHAM
THREE FLUTE CHAMDRILL



SOLID DRILL
SOLID CARBIDE



High Productivity Drilling

LOGIQ3CHAM
THREE FLUTE CHAMDRILL

3 Effective Cutting Edges,
Self-Centering Drill and Flat
Heads for Fast and Accurate
Drilling. Excellent Hole
Surface and Chip Evacuation.
Dia. Range of 12-25.9 mm



For Better Roundness
and Concentricity

**300%
Faster**



Self-Centering for
High Surface Quality



Flat Heads for
Flat Bottom Holes



1.5XD

3XD

5XD

8XD

VIDEO





VIDEO

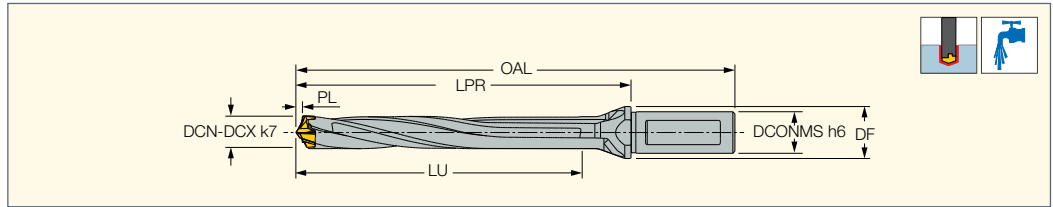

D3N A-8D

Exchangeable Head 3 Flute Drills
with Coolant Holes and One
Flat Shank, Drilling Depth 8xD



Designation	DCN ⁽¹⁾	DCX ⁽²⁾	DCONMS	DF	LU	LPR	PL	OAL	SSC ⁽³⁾	
D3N 120-096-16A-8D	12.00	12.40	16.00	20.00	98.71	120.92	2.710	168.90	12	K D3N 12-13.99
D3N 125-100-16A-8D	12.50	12.90	16.00	20.00	102.71	125.67	2.710	173.70	12	K D3N 12-13.99
D3N 130-104-16A-8D	13.00	13.40	16.00	20.00	106.91	131.08	2.910	179.10	13	K D3N 12-13.99
D3N 135-108-16A-8D	13.50	13.90	16.00	20.00	110.91	135.83	2.910	183.80	13	K D3N 12-13.99
D3N 140-112-16A-8D	14.00	14.40	16.00	20.00	115.10	141.08	3.100	189.10	14	K D3N 14-15.99
D3N 145-116-16A-8D	14.50	14.90	16.00	20.00	119.10	145.83	3.100	193.80	14	K D3N 14-15.99
D3N 150-120-20A-8D	15.00	15.90	20.00	25.00	123.47	151.16	3.470	201.20	15	K D3N 14-15.99
D3N 160-128-20A-8D	16.00	16.90	20.00	25.00	131.44	161.25	3.440	211.30	16	K D3N 16-17.99
D3N 170-136-20A-8D	17.00	17.90	20.00	25.00	139.52	171.22	3.520	221.30	17	K D3N 16-17.99
D3N 180-144-25A-8D	18.00	18.90	25.00	32.00	147.90	181.36	3.900	237.40	18	K D3N 18-19.99
D3N 190-152-25A-8D	19.00	19.90	25.00	32.00	156.10	191.42	4.100	247.40	19	K D3N 18-19.99
D3N 200-160-25A-8D	20.00	20.90	25.00	32.00	164.32	201.24	4.320	257.20	20	K D3N 20-21.99
D3N 210-168-25A-8D	21.00	21.90	25.00	32.00	172.55	211.30	4.550	267.30	21	K D3N 20-21.99
D3N 220-176-25A-8D	22.00	22.90	25.00	32.00	180.69	221.62	4.690	277.60	22	K D3N 22-23.99
D3N 230-184-32A-8D	23.00	23.90	32.00	42.00	188.91	231.50	4.910	291.50	23	K D3N 22-23.99
D3N 240-192-32A-8D	24.00	24.90	32.00	42.00	197.21	241.54	5.210	301.50	24	K D3N 24-25.99
D3N 250-200-32A-8D	25.00	25.90	32.00	42.00	205.31	251.72	5.120	311.70	25	K D3N 24-25.99

• Do not mount smaller drilling heads other than the specified range of the drill body

- (1) Cutting diameter minimum
- (2) Cutting diameter maximum
- (3) Seat size code

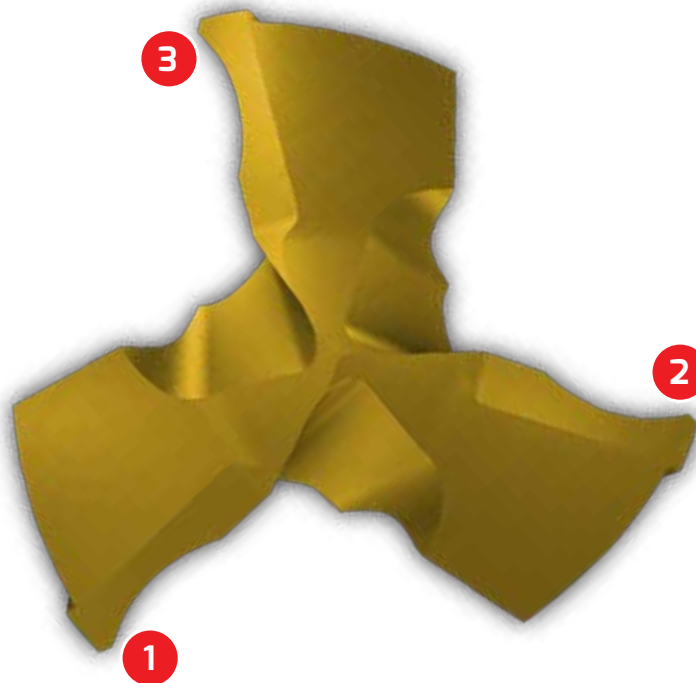

D3N R-8D

Exchangeable Head 3 Flute Drills with Coolant Holes and a Round Shank, Drilling Depth 8xD

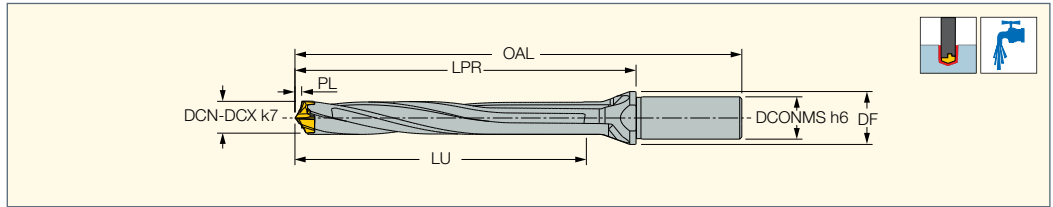

Designation	DCN ⁽¹⁾	DCX ⁽²⁾	DCONMS	DF	LU	LPR	PL	OAL	SSC ⁽³⁾	
D3N 120-096-16R-8D	12.00	12.40	16.00	20.00	98.71	120.92	2.710	168.90	12	K D3N 12-13.99
D3N 125-100-16R-8D	12.50	12.90	16.00	20.00	102.71	125.67	2.710	173.70	12	K D3N 12-13.99
D3N 130-104-16R-8D	13.00	13.40	16.00	20.00	106.91	131.08	2.910	179.10	13	K D3N 12-13.99
D3N 135-108-16R-8D	13.50	13.90	16.00	20.00	110.91	135.83	2.910	183.80	13	K D3N 12-13.99
D3N 140-112-16R-8D	14.00	14.40	16.00	20.00	115.10	141.08	3.100	189.10	14	K D3N 14-15.99
D3N 145-116-16R-8D	14.50	14.90	16.00	20.00	119.10	145.83	3.100	193.80	14	K D3N 14-15.99
D3N 150-120-20R-8D	15.00	15.90	20.00	25.00	123.47	151.16	3.470	201.20	15	K D3N 14-15.99
D3N 160-128-20R-8D	16.00	16.90	20.00	25.00	131.44	161.25	3.440	211.30	16	K D3N 16-17.99
D3N 170-136-20R-8D	17.00	17.90	20.00	25.00	139.52	171.22	3.520	221.20	17	K D3N 16-17.99
D3N 180-144-25R-8D	18.00	18.90	25.00	32.00	147.90	181.36	3.900	237.40	18	K D3N 18-19.99
D3N 190-152-25R-8D	19.00	19.90	25.00	32.00	156.10	191.42	4.100	247.40	19	K D3N 18-19.99
D3N 200-160-25R-8D	20.00	20.90	25.00	32.00	164.32	201.24	4.320	257.20	20	K D3N 20-21.99
D3N 210-168-25R-8D	21.00	21.90	25.00	32.00	172.55	211.30	4.550	267.30	21	K D3N 20-21.99
D3N 220-176-25R-8D	22.00	22.90	25.00	32.00	180.69	221.62	4.690	277.60	22	K D3N 22-23.99
D3N 230-184-32R-8D	23.00	23.90	32.00	42.00	188.91	231.50	4.910	291.50	23	K D3N 22-23.99
D3N 240-192-32R-8D	24.00	24.90	32.00	42.00	197.21	241.54	5.210	301.50	24	K D3N 24-25.99
D3N 250-200-32R-8D	25.00	25.90	32.00	42.00	205.31	251.72	5.120	311.70	25	K D3N 24-25.99

• Do not mount smaller drilling heads other than the specified range of the drill body

- (1) Cutting diameter minimum
- (2) Cutting diameter maximum
- (3) Seat size code



Self-Centering for High Surface Quality

F3P

Exchangeable 3 Flute Flat Drilling Heads for Machining Carbon and Alloy Steel (ISO P) and Cast Iron (ISO K)

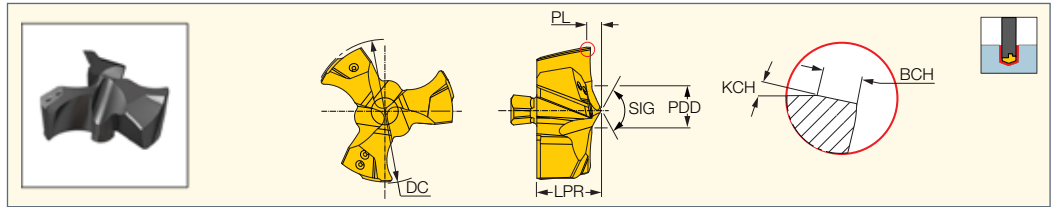

Designation	Dimensions								IC908
	DC	LPR ⁽¹⁾	PL	PDD	SIG	BCH	KCH	SSC ⁽²⁾	
F3P 120-IQ	12.00	4.90	0.790	2.96	133	0.40	15.0	12	●
F3P 125-IQ	12.50	4.90	0.790	2.96	133	0.40	15.0	12	●
F3P 130-IQ	13.00	5.39	0.990	3.52	130	0.40	15.0	13	●
F3P 135-IQ	13.50	5.39	0.990	3.52	130	0.40	15.0	13	●
F3P 140-IQ	14.00	6.42	1.110	4.16	124	0.40	15.0	14	●
F3P 145-IQ	14.50	6.42	1.110	4.16	124	0.40	15.0	14	●
F3P 150-IQ	15.00	6.72	1.190	3.81	121	0.40	15.0	15	●
F3P 155-IQ	15.50	6.72	1.190	3.81	121	0.40	15.0	15	●
F3P 160-IQ	16.00	7.03	1.090	3.95	121	0.40	15.0	16	●
F3P 165-IQ	16.50	7.03	1.090	3.95	121	0.40	15.0	16	●
F3P 170-IQ	17.00	7.70	1.160	4.09	121	0.40	15.0	17	●
F3P 175-IQ	17.50	7.70	1.160	4.09	121	0.40	15.0	17	●
F3P 180-IQ	18.00	8.02	1.230	5.86	131	0.40	15.0	18	●
F3P 185-IQ	18.50	8.02	1.230	5.86	131	0.40	15.0	18	●
F3P 190-IQ	19.00	8.09	1.270	6.19	131	0.40	15.0	19	●
F3P 195-IQ	19.50	8.09	1.270	6.19	131	0.40	15.0	19	●
F3P 200-IQ	20.00	8.59	1.340	6.54	132	0.40	15.0	20	●
F3P 205-IQ	20.50	8.59	1.340	6.54	132	0.40	15.0	20	●
F3P 210-IQ	21.00	9.02	1.410	6.92	132	0.40	15.0	21	●
F3P 215-IQ	21.50	9.02	1.410	6.92	132	0.40	15.0	21	●
F3P 220-IQ	22.00	9.97	1.680	7.19	132	0.40	15.0	22	●
F3P 225-IQ	22.50	9.97	1.680	7.19	132	0.40	15.0	22	●
F3P 230-IQ	23.00	10.17	1.750	7.66	132	0.40	15.0	23	●
F3P 235-IQ	23.50	10.17	1.750	7.66	132	0.40	15.0	23	●
F3P 240-IQ	24.00	10.59	1.820	7.79	132	0.40	15.0	24	●
F3P 245-IQ	24.50	10.59	1.820	7.79	132	0.40	15.0	24	●
F3P 250-IQ	25.00	10.81	1.660	8.09	131	0.40	15.0	25	●
F3P 255-IQ	25.50	10.81	1.660	8.09	131	0.40	15.0	25	●

● For nearly flat bottom hole applications

⁽¹⁾ LPR tolerance ± 0.05 mm

⁽²⁾ Seat size code



Flat Heads for Flat Bottom Holes



Extra Long Deep Drilling

SOLIDDRILL
SOLID CARBIDE

Extra Long 16, 20, 30, 40, 50xD
Solid Drills Designed to Function
Under Tough Deep Drilling
Conditions.



Spiral Channels with Internal Coolant
for **Efficient Lubrication**



Polished Flute Specially
Treated Surface for
Good Chip Evacuation



VIDEO



SOLIDDRILL

SCD-SXC16

Solid Carbide Drills with
Internal Coolant Channels,
Drilling Depth 16xD

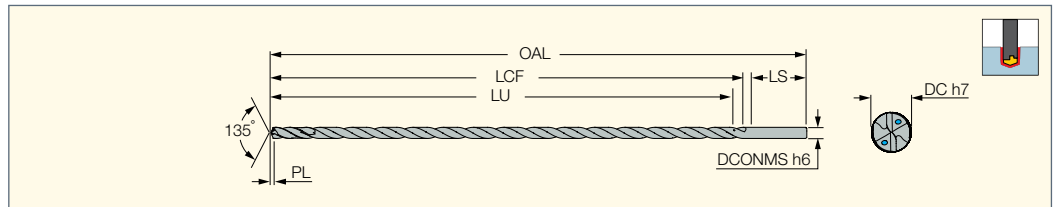

Designation	Dimensions								IC908
	DC	DCONMS	OAL	LU	LCF	LS	PL	ULDR ⁽¹⁾	
SCD 030-055-060 SXC16	3.00	6.00	100.00	55.00	60.0	36.0	0.495	16.0	●
SCD 032-055-060 SXC16	3.20	6.00	100.00	55.00	60.0	36.0	0.528	16.0	●
SCD 033-055-060 SXC16	3.30	6.00	100.00	55.00	60.0	36.0	0.544	16.0	●
SCD 035-054-060 SXC16	3.50	6.00	100.00	54.00	60.0	36.0	0.578	16.0	●
SCD 038-069-060 SXC16	3.80	6.00	115.00	69.00	75.0	36.0	0.627	16.0	●
SCD 040-069-060 SXC16	4.00	6.00	115.00	69.00	75.0	36.0	0.660	16.0	●
SCD 042-068-060 SXC16	4.20	6.00	115.00	68.00	75.0	36.0	0.693	16.0	●
SCD 045-083-060 SXC16	4.50	6.00	130.00	83.00	90.0	36.0	0.743	16.0	●
SCD 047-082-060 SXC16	4.70	6.00	130.00	82.00	90.0	36.0	0.775	16.0	●
SCD 048-082-060 SXC16	4.80	6.00	130.00	82.00	90.0	36.0	0.792	16.0	●
SCD 050-082-060 SXC16	5.00	6.00	130.00	82.00	90.0	36.0	0.825	16.0	●
SCD 055-099-060 SXC16	5.50	6.00	150.00	99.00	108.0	36.0	0.907	16.0	●
SCD 058-099-060 SXC16	5.80	6.00	150.00	99.00	108.0	36.0	0.957	16.0	●
SCD 060-099-060 SXC16	6.00	6.00	150.00	99.00	108.0	36.0	0.990	16.0	●
SCD 065-115-080 SXC16	6.50	8.00	165.00	115.00	125.0	36.0	1.073	16.0	●
SCD 068-114-080 SXC16	6.80	8.00	165.00	114.00	125.0	36.0	1.122	16.0	●
SCD 070-114-080 SXC16	7.00	8.00	165.00	114.00	125.0	36.0	1.155	16.0	●
SCD 075-128-080 SXC16	7.50	8.00	180.00	128.00	140.0	36.0	1.238	16.0	●
SCD 078-128-080 SXC16	7.80	8.00	180.00	128.00	140.0	36.0	1.287	16.0	●
SCD 080-128-080 SXC16	8.00	8.00	180.00	128.00	140.0	36.0	1.320	16.0	●
SCD 085-147-100 SXC16	8.50	10.00	205.00	147.00	160.0	40.0	1.403	16.0	●
SCD 088-146-100 SXC16	8.80	10.00	205.00	146.00	160.0	40.0	1.452	16.0	●
SCD 090-146-100 SXC16	9.00	10.00	205.00	146.00	160.0	40.0	1.485	16.0	●
SCD 098-165-100 SXC16	9.80	10.00	225.00	165.00	180.0	40.0	1.617	16.0	●
SCD 100-165-100 SXC16	10.00	10.00	225.00	165.00	180.0	40.0	1.650	16.0	●
SCD 102-174-120 SXC16	10.20	12.00	240.00	174.00	190.0	45.0	1.683	16.0	●
SCD 108-173-120 SXC16	10.80	12.00	240.00	173.00	190.0	45.0	1.782	16.0	●
SCD 110-173-120 SXC16	11.00	12.00	240.00	173.00	190.0	45.0	1.815	16.0	●
SCD 115-197-120 SXC16	11.50	12.00	265.00	197.00	215.0	45.0	1.898	16.0	●
SCD 120-197-120 SXC16	12.00	12.00	265.00	197.00	215.0	45.0	1.980	16.0	●
SCD 123-211-140 SXC16	12.30	14.00	280.00	211.00	230.0	45.0	2.030	16.0	●
SCD 130-210-140 SXC16	13.00	14.00	280.00	210.00	230.0	45.0	2.145	16.0	●
SCD 133-225-140 SXC16	13.30	14.00	295.00	225.00	245.0	45.0	2.195	16.0	●
SCD 135-224-140 SXC16	13.50	14.00	295.00	224.00	245.0	45.0	2.228	16.0	●
SCD 140-224-140 SXC16	14.00	14.00	295.00	224.00	245.0	45.0	2.310	16.0	●
SCD 145-233-160 SXC16	14.50	16.00	305.00	233.00	255.0	48.0	2.393	16.0	●
SCD 150-232-160 SXC16	15.00	16.00	305.00	232.00	255.0	48.0	2.475	16.0	●
SCD 155-251-160 SXC16	15.50	16.00	325.00	251.00	275.0	48.0	2.558	16.0	●
SCD 160-251-160 SXC16	16.00	16.00	325.00	251.00	275.0	48.0	2.640	16.0	●
SCD 165-295-180 SXC16	16.50	18.00	370.00	295.00	320.0	48.0	2.723	16.0	●
SCD 170-294-180 SXC16	17.00	18.00	370.00	294.00	320.0	48.0	2.805	16.0	●
SCD 175-293-180 SXC16	17.50	18.00	370.00	293.00	320.0	48.0	2.888	16.0	●
SCD 180-293-180 SXC16	18.00	18.00	370.00	293.00	320.0	48.0	2.970	16.0	●
SCD 185-302-200 SXC16	18.50	20.00	380.00	302.00	330.0	50.0	3.053	16.0	●
SCD 195-320-200 SXC16	19.50	20.00	400.00	320.00	350.0	50.0	3.217	16.0	●
SCD 200-320-200 SXC16	20.00	20.00	400.00	320.00	350.0	50.0	3.300	16.0	●

⁽¹⁾ Usable length diameter ratio

SOLIDDRILL

SCD-SXC20

Solid Carbide Drills with
Internal Coolant Channels,
Drilling Depth 20xD

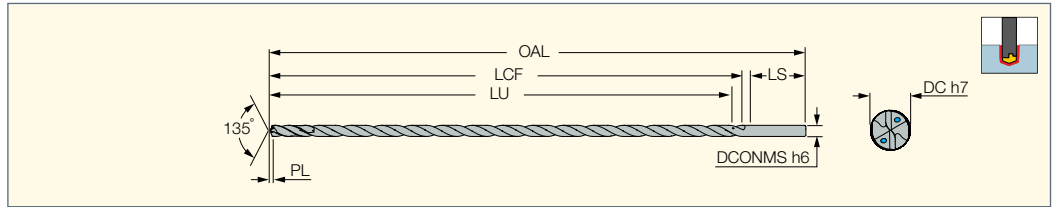

Designation	Dimensions								IC908
	DC	DCONMS	OAL	LU	LCF	LS	PL	ULDR ⁽¹⁾	
SCD 030-075-060 SXC20	3.00	6.00	120.00	75.00	80.0	36.0	0.495	20.0	●
SCD 032-075-060 SXC20	3.20	6.00	120.00	75.00	80.0	36.0	0.528	20.0	●
SCD 033-075-060 SXC20	3.30	6.00	120.00	75.00	80.0	36.0	0.544	20.0	●
SCD 035-074-060 SXC20	3.50	6.00	120.00	74.00	80.0	36.0	0.578	20.0	●
SCD 038-084-060 SXC20	3.80	6.00	130.00	84.00	90.0	36.0	0.627	20.0	●
SCD 040-084-060 SXC20	4.00	6.00	130.00	84.00	90.0	36.0	0.660	20.0	●
SCD 042-103-060 SXC20	4.20	6.00	160.00	103.00	110.0	36.0	0.693	20.0	●
SCD 045-103-060 SXC20	4.50	6.00	160.00	103.00	110.0	36.0	0.743	20.0	●
SCD 047-112-060 SXC20	4.70	6.00	160.00	112.00	120.0	36.0	0.775	20.0	●
SCD 048-112-060 SXC20	4.80	6.00	160.00	112.00	120.0	36.0	0.792	20.0	●
SCD 050-112-060 SXC20	5.00	6.00	160.00	112.00	120.0	36.0	0.825	20.0	●
SCD 055-131-060 SXC20	5.50	6.00	185.00	131.00	140.0	36.0	0.907	20.0	●
SCD 058-131-060 SXC20	5.80	6.00	185.00	131.00	140.0	36.0	0.957	20.0	●
SCD 060-131-060 SXC20	6.00	6.00	185.00	131.00	140.0	36.0	0.990	20.0	●
SCD 065-150-080 SXC20	6.50	8.00	210.00	150.00	160.0	36.0	1.073	20.0	●
SCD 068-149-080 SXC20	6.80	8.00	210.00	149.00	160.0	36.0	1.122	20.0	●
SCD 070-149-080 SXC20	7.00	8.00	210.00	149.00	160.0	36.0	1.155	20.0	●
SCD 075-168-080 SXC20	7.50	8.00	230.00	168.00	180.0	36.0	1.238	20.0	●
SCD 078-168-080 SXC20	7.80	8.00	230.00	168.00	180.0	36.0	1.287	20.0	●
SCD 080-168-080 SXC20	8.00	8.00	230.00	168.00	180.0	36.0	1.320	20.0	●
SCD 085-182-100 SXC20	8.50	10.00	260.00	182.00	195.0	40.0	1.403	20.0	●
SCD 088-216-100 SXC20	8.80	10.00	290.00	216.00	230.0	40.0	1.452	20.0	●
SCD 090-216-100 SXC20	9.00	10.00	290.00	216.00	230.0	40.0	1.485	20.0	●
SCD 098-215-100 SXC20	9.80	10.00	290.00	215.00	230.0	40.0	1.617	20.0	●
SCD 100-215-100 SXC20	10.00	10.00	290.00	215.00	230.0	40.0	1.650	20.0	●
SCD 102-252-120 SXC20	10.20	12.00	315.00	252.00	268.0	45.0	1.683	20.0	●
SCD 108-251-120 SXC20	10.80	12.00	315.00	251.00	268.0	45.0	1.782	20.0	●
SCD 110-251-120 SXC20	11.00	12.00	315.00	251.00	268.0	45.0	1.815	20.0	●
SCD 115-250-120 SXC20	11.50	12.00	315.00	250.00	268.0	45.0	1.898	20.0	●
SCD 120-250-120 SXC20	12.00	12.00	315.00	250.00	268.0	45.0	1.980	20.0	●
SCD 123-261-140 SXC20	12.30	14.00	325.00	261.00	280.0	45.0	2.030	20.0	●
SCD 130-260-140 SXC20	13.00	14.00	325.00	260.00	280.0	45.0	2.145	20.0	●
SCD 133-285-140 SXC20	13.30	14.00	355.00	285.00	305.0	45.0	2.195	20.0	●
SCD 135-284-140 SXC20	13.50	14.00	355.00	284.00	305.0	45.0	2.228	20.0	●
SCD 140-284-140 SXC20	14.00	14.00	355.00	284.00	305.0	45.0	2.310	20.0	●
SCD 145-298-160 SXC20	14.50	16.00	370.00	298.00	320.0	48.0	2.393	20.0	●
SCD 150-297-160 SXC20	15.00	16.00	370.00	297.00	320.0	48.0	2.475	20.0	●
SCD 155-326-160 SXC20	15.50	16.00	400.00	326.00	350.0	48.0	2.558	20.0	●
SCD 160-326-160 SXC20	16.00	16.00	400.00	326.00	350.0	48.0	2.640	20.0	●

⁽¹⁾ Usable length diameter ratio

Recommended Machining Conditions for SCD-SXC16 & SCD-SXC20 Solid Carbide Drills

ISO	Material	Condition	Tensile Strength [N/mm ²]	Hardness HB	Material Group No.	Cutting Speed V _c (m/min)	Cutting Diameter										
							Feed (mm/rev)										
							3.0-5.0	5.0-8.0	8.0-10.0	10-16	16-20						
P	Non-alloy steel and cast steel, free cutting steel	<0.25% C	Annealed	420	125	1	70-90	0.1-0.18	0.14-0.24	0.16-0.26	0.18-0.3	0.2-0.35					
		≥0.25% C	Annealed	650	190	2											
		<0.55% C	Quenched and tempered	850	250	3											
			Annealed	750	220	4											
			Quenched and tempered	1000	300	5											
	Low alloy and cast steel (less than 5% of alloying elements)		Annealed	600	200	6											
		Quenched and tempered		930	275	7											
				1000	300	8											
				1200	350	9											
	High alloyed steel, cast steel and tool steel	Annealed	680	200	10	75-85											
		Quenched and tempered	1100	325	11												
	Stainless steel and cast steel	Ferritic/martensitic	680	200	12	60-70							0.08-0.14	0.1-0.18	0.12-0.2	0.14-0.22	0.16-0.24
		Martensitic	820	240	13												
M	Stainless steel and cast steel	Austenitic, duplex	600	180	14	55-65	0.06-0.14	0.08-0.16	0.1-0.18	0.12-0.2	0.14-0.24						
K	Gray cast iron (GG)	Ferritic / pearlitic		180	15	80-100	0.14-0.24	0.16-0.26	0.18-0.3	0.2-0.35	0.25-0.45						
		Pearlitic / martensitic		260	16												
	Nodular cast iron (GGG)	Ferritic		160	17												
		Pearlitic		250	18												
	Malleable cast iron	Ferritic		130	19												
		Pearlitic		230	20												
S	High temperature alloys	Fe based	Annealed		200	31	35-45	0.06-0.12	0.08-0.16	0.1-0.18	0.12-0.2	0.12-0.22					
			Hardened		280	32											
		Ni or Co based	Annealed		250	33											
			Hardened		350	34											
	Titanium alloys	Pure	Cast		320	35	30-40	0.06-0.12	0.08-0.16	0.1-0.18	0.12-0.2	0.12-0.22					
				RM 400	190	36											
			Alpha+Beta alloys, hardened	RM 1050	310	37							35-45	0.06-0.12	0.08-0.16	0.1-0.18	0.12-0.2



**Spiral Channels with Internal
Coolant for Efficient Lubrication**

SOLIDDRILL

SCD-SXC30

Solid Carbide Drills with Internal Coolant Channels, Drilling Depth 30xD

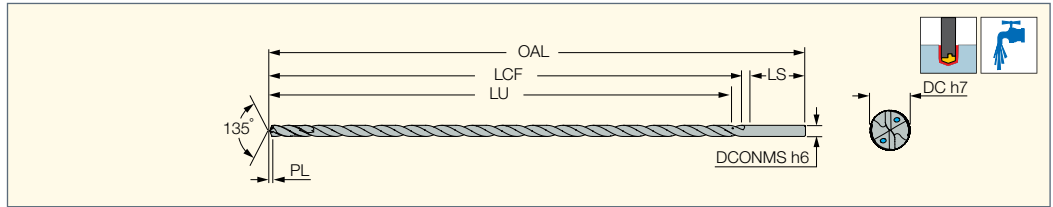

Designation	Dimensions								IC908
	DC	DCONMS	OAL	LU	LCF	LS	PL	ULDR ⁽²⁾	
SCD 030-097-060 SXC30	3.00	6.00	150.00	97.00	105.0	40.0	0.495	30.0	●
SCD 032-097-060 SXC30	3.20	6.00	150.00	97.00	105.0	40.0	0.528	30.0	●
SCD 033-127-060 SXC30	3.30	6.00	185.00	127.00	135.0	45.0	0.544	30.0	●
SCD 035-127-060 SXC30	3.50	6.00	185.00	127.00	135.0	45.0	0.578	30.0	●
SCD 038-127-060 SXC30 ⁽¹⁾	3.80	6.00	185.00	127.00	135.0	45.0	0.627	30.0	●
SCD 040-127-060 SXC30	4.00	6.00	185.00	127.00	135.0	45.0	0.660	30.0	●
SCD 042-127-060 SXC30	4.20	6.00	185.00	127.00	135.0	45.0	0.693	30.0	●
SCD 045-157-060 SXC30	4.50	6.00	215.00	157.00	165.0	45.0	0.743	30.0	●
SCD 047-157-060 SXC30 ⁽¹⁾	4.70	6.00	215.00	157.00	165.0	45.0	0.775	30.0	●
SCD 048-157-060 SXC30	4.80	6.00	215.00	157.00	165.0	45.0	0.792	30.0	●
SCD 050-157-060 SXC30	5.00	6.00	215.00	157.00	165.0	45.0	0.825	30.0	●
SCD 055-172-060 SXC30	5.50	6.00	230.00	172.00	180.0	45.0	0.907	30.0	●
SCD 058-172-060 SXC30 ⁽¹⁾	5.80	6.00	230.00	172.00	180.0	45.0	0.957	30.0	●
SCD 060-172-060 SXC30	6.00	6.00	230.00	172.00	180.0	45.0	0.990	30.0	●
SCD 065-207-080 SXC30	6.50	8.00	280.00	207.00	215.0	60.0	1.072	30.0	●
SCD 068-222-080 SXC30	6.80	8.00	280.00	222.00	230.0	45.0	1.122	30.0	●
SCD 070-222-080 SXC30	7.00	8.00	280.00	222.00	230.0	45.0	1.155	30.0	●
SCD 075-222-080 SXC30 ⁽¹⁾	7.50	8.00	280.00	222.00	230.0	45.0	1.238	30.0	●
SCD 078-257-080 SXC30 ⁽¹⁾	7.80	8.00	315.00	257.00	265.0	45.0	1.287	30.0	●
SCD 080-257-080 SXC30	8.00	8.00	315.00	257.00	265.0	45.0	1.320	30.0	●
SCD 085-287-100 SXC30	8.50	10.00	350.00	287.00	295.0	50.0	1.402	30.0	●
SCD 088-322-100 SXC30 ⁽¹⁾	8.80	10.00	380.00	322.00	330.0	45.0	1.452	30.0	●
SCD 090-322-100 SXC30	9.00	10.00	380.00	322.00	330.0	45.0	1.485	30.0	●
SCD 098-322-100 SXC30	9.80	10.00	380.00	322.00	330.0	45.0	1.617	30.0	●
SCD 100-322-100 SXC30	10.00	10.00	380.00	322.00	330.0	45.0	1.650	30.0	●

⁽¹⁾ On request

⁽²⁾ Usable length diameter ratio

Recommended Machining Conditions for SCD-SXC30 Solid Carbide Drills

ISO	Material	Condition	Tensile Strength [N/mm ²]	Hardness HB	Material No.	Cutting Speed V _c (m/min)	Cutting Diameter Feed (mm/rev)				
							3.0-5.0	5.0-8.0	8.0-10.0		
P	Non-alloy steel and cast steel, free cutting steel	< 0.25 %C	Annealed	420	125	1	65-75	0.08-0.16	0.12-0.2	0.16-0.24	
		>= 0.25 %C	Annealed	650	190	2					
		< 0.55 %C	Quenched and tempered	850	250	3					
		>= 0.55 %C	Annealed	750	220	4					
		>= 0.55 %C	Quenched and tempered	1000	300	5					
	Low alloy steel and cast steel (less than 5% of alloying elements)	Quenched and tempered	Annealed	600	200	6					60-70
			930	275	7						
			1000	300	8						
			1200	350	9						
	High alloyed steel, cast steel, and tool steel	Annealed	680	200	10	60-70					
Quenched and tempered		1100	325	11							
Stainless steel and cast steel	Ferritic/martensitic	680	200	12	45-55	0.06-0.12	0.08-0.16	0.1-0.18			
	Martensitic	820	240	13							
M	Stainless steel and cast steel	Austenitic	600	180	14	35-45	0.06-0.12	0.08-0.16	0.1-0.18		
K	Grey cast iron (GG)	Ferritic/pearlitic		180	15	75-85	0.14-0.22	0.18-0.30	0.22-0.40		
		Pearlitic		260	16						
	Cast iron nodular (GGG)	Ferritic		160	17						
		Pearlitic		250	18						
	Malleable cast iron	Ferritic		130	19						
S	High temp. alloys	Fe based	Annealed	200	31	35-50	0.06-0.12	0.08-0.16	0.1-0.18		
			Cured	280	32						
		Ni or Co based	Annealed	250	33						
			Cured	350	34						
	Titanium Ti alloys	Cast		320	35	35-50	0.06-0.12	0.08-0.16	0.1-0.18		
			Pure	RM 400	110					36	
			Alpha+beta alloys cured	RM 1050	310					37	

SCD-SXC40

Solid Carbide Drills with Internal Coolant Channels, Drilling Depth 40xD

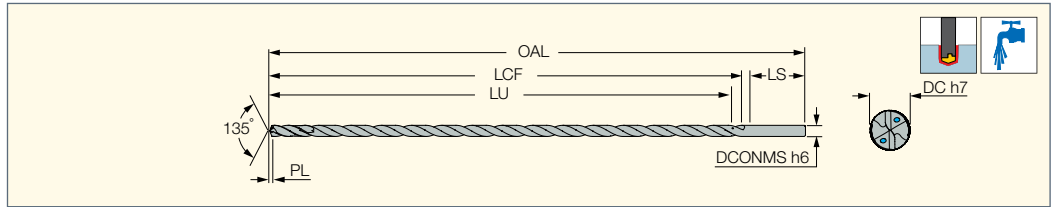

Designation	Dimensions								IC908
	DC	DCONMS	OAL	LU	LCF	LS	PL	ULDR ⁽²⁾	
SCD 030-132-060 SXC40	3.00	6.00	190.00	132.00	140.00	45.00	0.495	40.00	●
SCD 038-172-060 SXC40 ⁽¹⁾	3.80	6.00	230.00	172.00	180.00	45.00	0.627	40.00	●
SCD 040-172-060 SXC40	4.00	6.00	230.00	172.00	180.00	45.00	0.660	40.00	●
SCD 042-172-060 SXC40	4.20	6.00	230.00	172.00	180.00	45.00	0.693	40.00	●
SCD 045-212-060 SXC40	4.50	6.00	270.00	212.00	220.00	45.00	0.743	40.00	●
SCD 047-212-060 SXC40 ⁽¹⁾	4.70	6.00	270.00	212.00	220.00	45.00	0.775	40.00	●
SCD 048-212-060 SXC40	4.80	6.00	270.00	212.00	220.00	45.00	0.792	40.00	●
SCD 050-212-060 SXC40	5.00	6.00	270.00	212.00	220.00	45.00	0.825	40.00	●
SCD 055-232-060 SXC40	5.50	6.00	290.00	232.00	240.00	45.00	0.907	40.00	●
SCD 058-232-060 SXC40 ⁽¹⁾	5.80	6.00	290.00	232.00	240.00	45.00	0.957	40.00	●
SCD 060-232-060 SXC40	6.00	6.00	290.00	232.00	240.00	45.00	0.990	40.00	●
SCD 065-282-080 SXC40	6.50	8.00	340.00	282.00	290.00	45.00	1.072	40.00	●
SCD 068-312-080 SXC40	6.80	8.00	370.00	312.00	320.00	45.00	1.122	40.00	●
SCD 070-312-080 SXC40	7.00	8.00	370.00	312.00	320.00	45.00	1.155	40.00	●
SCD 075-312-080 SXC40 ⁽¹⁾	7.50	8.00	370.00	312.00	320.00	45.00	1.238	40.00	●
SCD 078-342-080 SXC40 ⁽¹⁾	7.80	8.00	400.00	342.00	350.00	45.00	1.287	40.00	●
SCD 080-342-080 SXC40	8.00	8.00	400.00	342.00	350.00	45.00	1.320	40.00	●

⁽¹⁾ On request

⁽²⁾ Usable length diameter ratio

Recommended Machining Conditions for SCD-SXC40 & SCD-SXC50 Solid Carbide Drills

ISO	Material	Condition	Tensile Strength [N/mm ²]	Hardness HB	Material No.	Cutting Speed V _c (m/min)	Cutting Diameter Feed (mm/rev)					
							3.0-4.0	4.1-5.0	5.1-6.0	6.1-7.0	7.1-8.0	
P	Non-alloy steel and cast steel, free cutting steel	< 0.25 %C	Annealed	420	125	1	55-65	0.06-0.12	0.06-0.14	0.08-0.16	0.10-0.18	0.12-0.2
		>= 0.25 %C	Annealed	650	190	2						
		< 0.55 %C	Quenched and tempered	850	250	3						
		>= 0.55 %C	Annealed	750	220	4						
		>= 0.55 %C	Quenched and tempered	1000	300	5						
	Low alloy steel and cast steel (less than 5% of alloying elements)	Annealed	600	200	6	45-65	0.06-0.10	0.06-0.12	0.08-0.14	0.10-0.16	0.12-0.18	
		Quenched and tempered	930	275	7							
		Quenched and tempered	1000	300	8							
	High alloyed steel, cast steel, and tool steel	Annealed	680	200	10	35-55	0.04-0.08	0.06-0.10	0.06-0.12	0.08-0.14	0.10-0.16	
		Quenched and tempered	1100	325	11							
Stainless steel and cast steel	Ferritic/martensitic	680	200	12	30-45	0.04-0.08	0.06-0.10	0.06-0.12	0.08-0.14	0.10-0.16		
	Martensitic	820	240	13								
M	Stainless steel and cast steel	Austenitic	600	180	14	25-45	0.04-0.08	0.06-0.10	0.06-0.12	0.08-0.14	0.10-0.16	
K	Grey cast iron (GG)	Ferritic/pearlitic		180	15	60-70	0.10-0.18	0.12-0.20	0.14-0.22	0.14-0.24	0.16-0.26	
		Pearlitic		260	16							
	Cast iron nodular (GGG)	Ferritic		160	17	55-65						
		Pearlitic		250	18							
	Malleable cast iron	Ferritic		130	19	50-60						
Pearlitic			230	20								
S	High temp. alloys	Fe based	Annealed		200	31	30-35	0.04-0.08	0.06-0.10	0.06-0.12	0.08-0.14	0.10-0.16
			Cured		280	32						
		Ni or Co based	Annealed		250	33						
			Cured		350	34						
	Titanium Ti alloys	Alpha+beta alloys cured	Cast		320	35	25-30	0.04-0.08	0.06-0.10	0.06-0.12	0.08-0.14	0.10-0.16
			Pure	RM 400	110	36						
			Pure	RM 1050	310	37						

SOLIDDRILL

SCD-SXC50

Solid Carbide Drills with Internal Coolant Channels, Drilling Depth 50xD

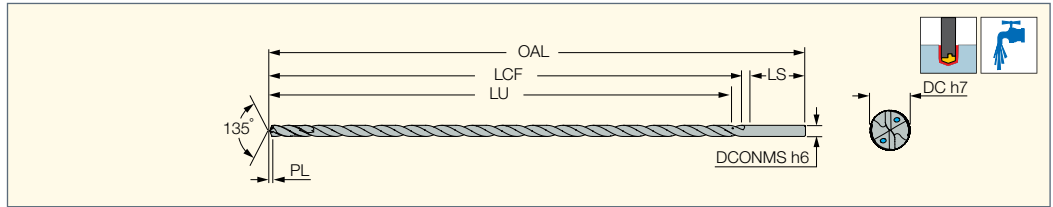

Designation	Dimensions								IC908
	DC	DCONMS	OAL	LU	LCF	LS	PL	ULDR ⁽²⁾	
SCD 040-217-060 SXC50	4.00	6.00	270.00	217.00	225.00	40.00	0.660	50.00	●
SCD 042-217-060 SXC50	4.20	6.00	270.00	217.00	225.00	40.00	0.693	50.00	●
SCD 045-267-060 SXC50	4.50	6.00	320.00	267.00	275.00	40.00	0.743	50.00	●
SCD 047-267-060 SXC50 ⁽¹⁾	4.70	6.00	320.00	267.00	275.00	40.00	0.775	50.00	●
SCD 048-267-060 SXC50	4.80	6.00	320.00	267.00	275.00	40.00	0.792	50.00	●
SCD 050-267-060 SXC50	5.00	6.00	320.00	267.00	275.00	40.00	0.825	50.00	●
SCD 055-302-060 SXC50	5.50	6.00	360.00	302.00	310.00	45.00	0.907	50.00	●
SCD 058-302-060 SXC50 ⁽¹⁾	5.80	6.00	360.00	302.00	310.00	45.00	0.957	50.00	●
SCD 060-302-060 SXC50	6.00	6.00	360.00	302.00	310.00	45.00	0.990	50.00	●

⁽¹⁾ On request

⁽²⁾ Usable length diameter ratio

Recommended Drilling Procedure for Deep Hole Drilling

- 1 Drill a pilot hole 1-2xD deep with a short drill. The pilot drill should be 0.03-0.05 mm larger than the long drill and its point angle should also be larger (over 135°).
- 2 Enter the pre-hole using low feed and rotate at low speed (50-100 RPM) until it engages the material.
- 3 Activate the coolant system and increase rotation speed to the recommended cutting parameter, maintain for 2-3 seconds, then continue at recommended drilling feed. **No pecking is required.**
- 4 After having reached the required depth, reduce speed to 50-100 RPM before retracting from the hole.

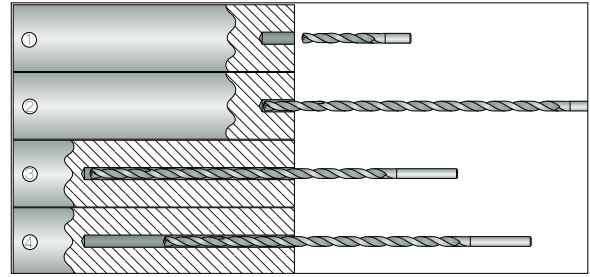

- 40xD & 50xD must utilize a 20xD intermediary drill along with pilot drill.

- In through holes, the tool exit should not exceed 2-3 mm.





NEOLOGIQ MILL

MACHINING INTELLIGENTLY



NEODO
S90° LINE



LOGIQ4FEED
HIGH FEED MILLING



HELISLOT
HELICAL SLOTTING LINE



Unique Exact 90° Shouldering

NEODO
S90° LINE

A New Milling Line for Square Shoulder and Face Milling.
A Unique Exact 90° Profile with 8 Cutting Edges in Combination with a **Dovetail Clamping Method** Enables Higher Cutting Conditions and Assures Better Productivity.



Unique **Exact 90°** Profile with **8 Cutting Edges**

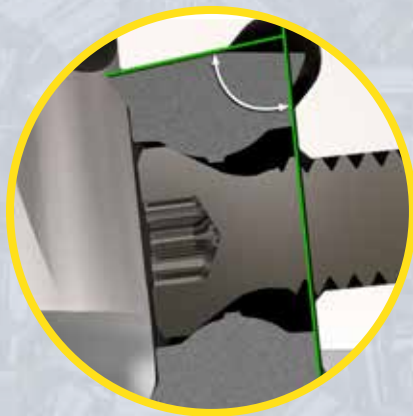

Dovetail Insert **Pocket** Locks the Insert Firmly in the Tool



VIDEO



S890 FSZ-R08

Face Mills Carrying
Double-Sided Square Inserts
with 8 Cutting Edges

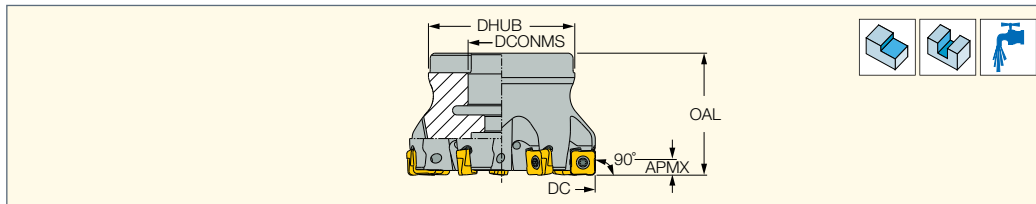

Designation	DC	APMX	OAL	CICT ⁽¹⁾	DCONMS	DHUB	Arbor	MIID ⁽²⁾	
S890 FSZ D032-04-16-R08	32.00	5.00	32.00	4	16.00	30.00	A	S890 SZMU 0804...	0.20
S890 FSZ D040-05-16-R08	40.00	5.00	35.00	5	16.00	38.00	A	S890 SZMU 0804...	0.24
S890 FSZ D040-06-16-R08	40.00	5.00	35.00	6	16.00	38.00	A	S890 SZMU 0804...	0.34
S890 FSZ D050-06-22-R08	50.00	5.00	40.00	6	22.00	48.00	A	S890 SZMU 0804...	0.35
S890 FSZ D050-08-22-R08	50.00	5.00	40.00	8	22.00	48.00	A	S890 SZMU 0804...	0.39
S890 FSZ D063-07-22-R08	63.00	5.00	40.00	7	22.00	48.00	A	S890 SZMU 0804...	0.60
S890 FSZ D063-10-22-R08	63.00	5.00	40.00	10	22.00	48.00	A	S890 SZMU 0804...	0.58
S890 FSZ D080-08-27-R08	80.00	5.00	50.00	8	27.00	60.00	B	S890 SZMU 0804...	0.98
S890 FSZ D080-12-27-R08	80.00	5.00	50.00	12	27.00	60.00	B	S890 SZMU 0804...	0.93
S890 FSZ D100-10-32-R08	100.00	5.00	50.00	10	32.00	78.00	B	S890 SZMU 0804...	1.52
S890 FSZ D100-14-32-R08	100.00	5.00	50.00	14	32.00	78.00	B	S890 SZMU 0804...	1.50
S890 FSZ D125-12-40-R08	125.00	5.00	50.00	12	40.00	92.00	B	S890 SZMU 0804...	2.29
S890 FSZ D125-18-40-R08	125.00	5.00	50.00	18	40.00	92.00	B	S890 SZMU 0804...	2.32

⁽¹⁾ Number of inserts

⁽²⁾ Master insert identification

Spare Parts

Designation			
S890 FSZ D032-04-16-R08	SR M3X0.5-L7.4 IP9 ^(a)	IP-9/151 ^(b)	SR M8X32 D11-C50-H6
S890 FSZ D040-05-16-R08	SR M3X0.5-L7.4 IP9 ^(a)	IP-9/151 ^(b)	SR M8X25DIN912
S890 FSZ D040-06-16-R08	SR M3X0.5-L7.4 IP9 ^(a)	IP-9/151 ^(b)	SR M8X25DIN912
S890 FSZ D050-06-22-R08	SR M3X0.5-L7.4 IP9 ^(a)	IP-9/151 ^(b)	SR M10X25 DIN912
S890 FSZ D050-08-22-R08	SR M3X0.5-L7.4 IP9 ^(a)	IP-9/151 ^(b)	SR M10X25 DIN912
S890 FSZ D063-07-22-R08	SR M3X0.5-L7.4 IP9 ^(a)	IP-9/151 ^(b)	SR M10X25 DIN912
S890 FSZ D063-10-22-R08	SR M3X0.5-L7.4 IP9 ^(a)	IP-9/151 ^(b)	SR M10X25 DIN912
S890 FSZ D080-08-27-R08	SR M3X0.5-L7.4 IP9 ^(a)	IP-9/151 ^(b)	
S890 FSZ D080-12-27-R08	SR M3X0.5-L7.4 IP9 ^(a)	IP-9/151 ^(b)	
S890 FSZ D100-10-32-R08	SR M3X0.5-L7.4 IP9 ^(a)	IP-9/151 ^(b)	
S890 FSZ D100-14-32-R08	SR M3X0.5-L7.4 IP9 ^(a)	IP-9/151 ^(b)	
S890 FSZ D125-12-40-R08	SR M3X0.5-L7.4 IP9 ^(a)	IP-9/151 ^(b)	
S890 FSZ D125-18-40-R08	SR M3X0.5-L7.4 IP9 ^(a)	IP-9/151 ^(b)	

^(a) Recommended tightening torque: 2 N*m

^(b) For limiting torque, use optional 7007382 BLD 4 IP09-2.0NM blade & 7007320 HSD 4-2.0NM handle.

S890 SZMU-0804PN
Double-Sided Square Inserts
with 8 Cutting Edges

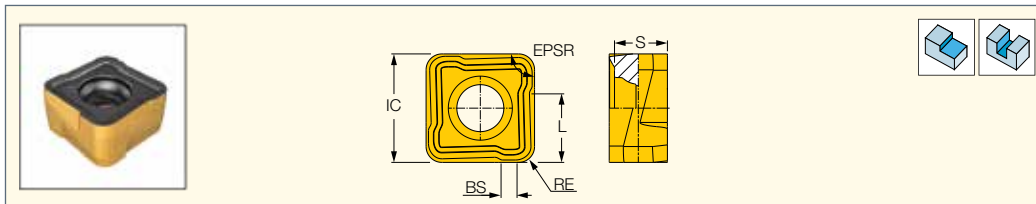

Designation	Dimensions							Tough ↔ Hard						Recommended Machining Data f _z (mm/t)
	IC	S	L	APMX	BS	RE	EPSR	IC845	IC830	IC5400	IC808	IC810	IC5100	
S890 SZMU 080408PNTR	8.20	4.00	5.20	5.00	1.60	0.80	88.4					•		0.12-0.25
S890 SZMU 080412PNTR	8.20	4.00	5.20	5.00	1.20	1.20	88.4					•	•	0.12-0.25
S890 SZMU 080408PNRMM	8.20	4.00	5.20	5.00	1.60	0.80	88.4		•		•			0.08-0.25
S890 SZMU 080412PNRMM	8.20	4.00	5.20	5.00	1.20	1.20	88.4	•	•	•	•			0.08-0.25

When stepdown milling is performed by use of passes, the depth of cut per pass should not exceed the depth of cut as recommended in the ISCAR catalog.

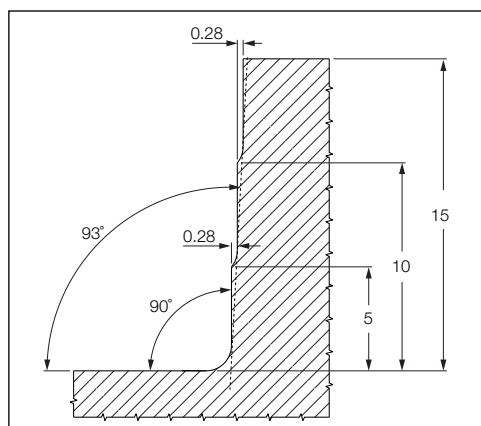

Generated profile for a depth of cut in stepdown milling

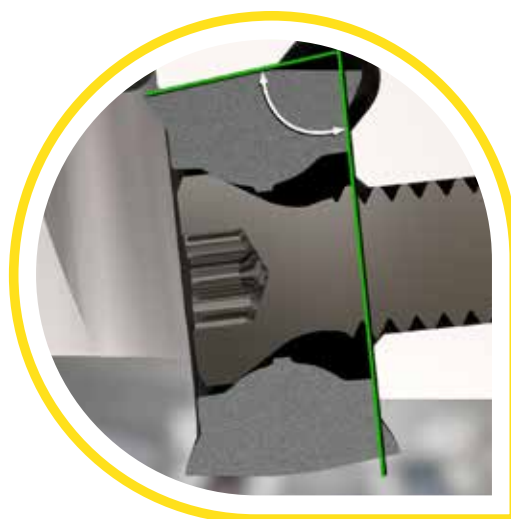

Dovetail Insert Pocket Locks the Insert Firmly in Place





High Feed Milling

LOGIQ4FEED
HIGH FEED MILLING

Unique Twisted High Positive **4 Cutting Edged** Insert. A Range of Tools from 12 mm Endmills up to 125 mm Facemills. This New Line of Tools Enables Machining at Very High Feeds for **High Productivity**.



Size 08 mm

Dia. Range: 50 - 125 mm
for Facemills



Size 04 mm

Dia. Range: 12 - 32 mm
for Endmills

VIDEO



FFX4 FD-08

Face Mills Carrying "Bone Shaped" Inserts with 4 Cutting Edges for Fast Feed Milling

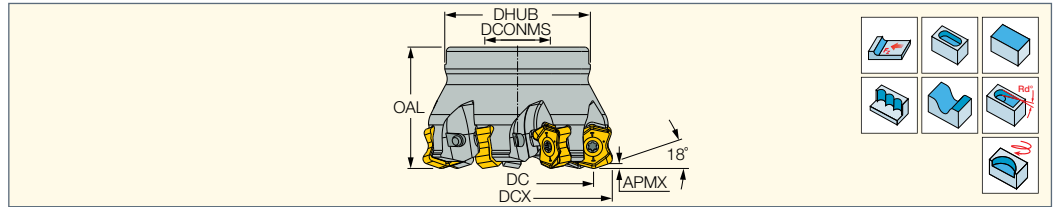

Designation	DCX ⁽¹⁾	DC	CICT ⁽²⁾	APMX	AE	OAL	DCONMS	DHUB	Rd°	MDN ⁽³⁾	MDX ⁽⁴⁾	Arbor	Rg ⁽⁵⁾	MIID ⁽⁶⁾	
FFX4 FD050-4-22-08	50.00	34.40	4	2.00	7.8	50.00	22.00	48.00	3.3	84.40	99.00	A	4.00	FFX4 XNMU 080620	0.58
FFX4 FD063-5-22-08	63.00	47.40	5	2.00	7.8	45.00	22.00	48.00	2.3	110.40	125.00	A	4.00	FFX4 XNMU 080620T	0.48
FFX4 FD080-7-27-08	80.00	64.40	7	2.00	7.8	50.00	27.00	60.00	1.6	144.40	159.00	B	4.00	FFX4 XNMU 080620T	0.95
FFX4 FD100-8-32-08	100.00	84.40	8	2.00	7.8	50.00	32.00	78.00	1.2	184.40	199.00	B	4.00	FFX4 XNMU 080620T	1.24
FFX4 FD125-10-40-08	125.00	109.40	10	2.00	7.8	63.00	40.00	92.00	0.9	234.40	249.00	B	4.00	FFX4 XNMU 080620T	2.40

• To generate a straight surface without cusps, the width of cut must not exceed DC

- (1) Cutting diameter maximum
- (2) Number of inserts
- (3) Machinable diameter minimum for interpolation
- (4) Machinable diameter maximum for interpolation
- (5) Radius for programming
- (6) Master insert identification

Spare Parts

Designation				
FFX4 FD050-4-22-08	SR M5-14 IP20	SW6-T	BLD IP20/S7	SR PS 118-0273
FFX4 FD063-5-22-08	SR M5-14 IP20	SW6-T	BLD IP20/S7	SR M10X25 DIN912
FFX4 FD080-7-27-08	SR M5-14 IP20	SW6-T	BLD IP20/S7	SR M12X30DIN912
FFX4 FD100-8-32-08	SR M5-14 IP20	SW6-T	BLD IP20/S7	
FFX4 FD125-10-40-08	SR M5-14 IP20	SW6-T	BLD IP20/S7	

FFX4 XNMU-08

"Bone Shaped" Inserts with 4 Cutting Edges for Fast Feed Milling

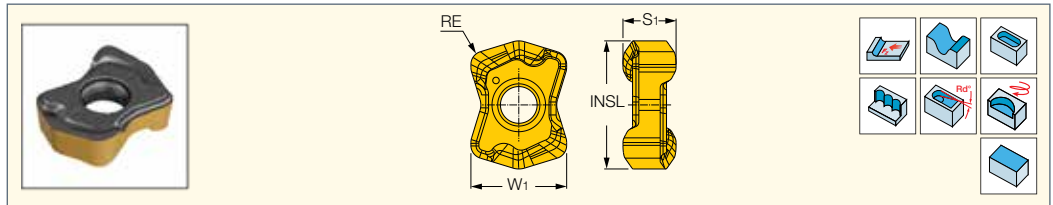

Designation	Dimensions				Tough ↔ Hard				Recommended Machining Data	
	INSL	S1	RE	W1	IC882	IC830	IC808	IC810	a _p (mm)	f _z (mm/t)
FFX4 XNMU 080620HP	17.90	7.80	2.00	15.60	●	●	●	●	0.20-2.00	0.20-0.80
FFX4 XNMU 080620T	17.90	7.80	2.00	15.60		●	●	●	0.20-2.00	0.40-1.20

- For side plunging, the initial cutting feed is 0.1 mm/t
- T-for steel, ferritic and martensitic stainless steel, cast iron and hardened steel
- HP-for austenitic stainless steel and high temperature alloys



Efficient Slot Milling

HELISLOT
HELICAL SLOTTING LINE

Unique Twisted High Positive Double-Sided Insert with **4 Right - and 4 Left Hand** Cutting Edges. Slotting Width Range of 10–24 mm.



Helical Edge for Easy and Soft Cut

NEW



XNMU 09

Slot Width Range:
10 – 14 mm
Dia. Tool Range: 32-160 mm

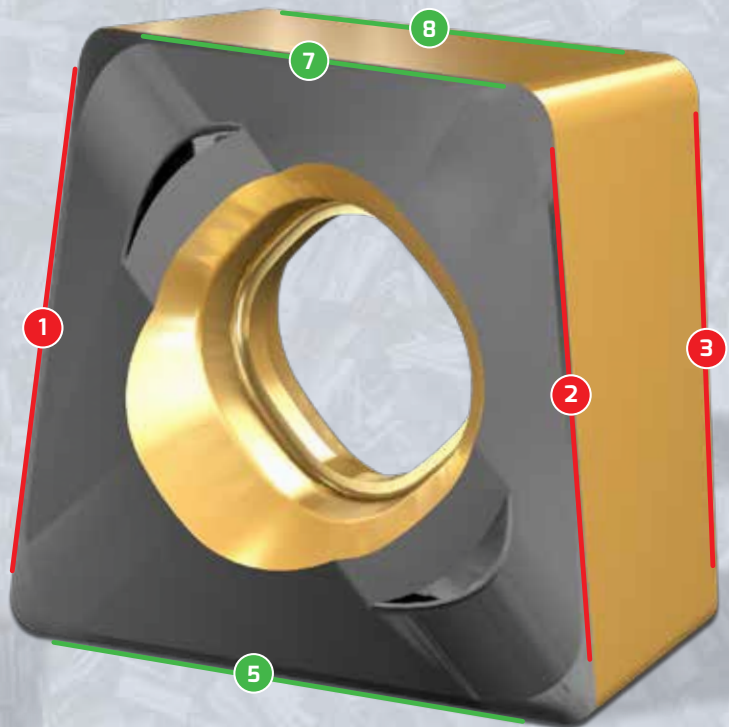

XNMU 13

Slot Width Range:
14 – 24 mm
Dia. Tool Range: 40-200 mm

VIDEO



HELISLOT

FDN-XN09

Full Slot Flange Type Slotting
Cutters Carrying XNMU 0904
Square Inserts with 4 Right- and
4 Left-Hand Cutting Edges

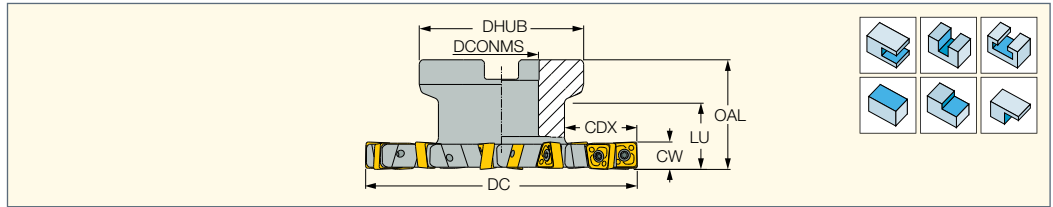



Designation	DC	CW	CICT ⁽¹⁾	ZEFP	CDX ⁽²⁾	DHUB	DCONMS	LU	OAL	Arbor	
FDN D080-10-22-XN09	80.00	10.00	10	10	22.50	48.00	22.00	27.0	40.00	A	0.40
FDN D080-12-22-XN09	80.00	12.00	10	5	22.50	48.00	22.00	27.0	40.00	A	0.43
FDN D100-10-27-XN09	100.00	10.00	12	12	26.00	60.00	27.00	25.0	40.00	B	0.64
FDN D100-12-27-XN09	100.00	12.00	12	6	26.00	60.00	27.00	25.0	40.00	B	0.92
FDN D125-10-32-XN09	125.00	10.00	14	14	33.00	65.00	32.00	31.0	45.00	B	1.19
FDN D125-12-32-XN09	125.00	12.00	14	7	33.00	65.00	32.00	31.0	45.00	B	1.08
FDN D160-10-40-XN09	160.00	10.00	18	18	45.00	80.00	40.00	35.0	50.00	B	1.45
FDN D160-12-40-XN09	160.00	12.00	18	9	45.00	80.00	40.00	35.0	50.00	B	1.78

⁽¹⁾ Number of inserts

⁽²⁾ Cutting depth maximum

Spare Parts

Designation		
FDN-XN09	SR 10508600	T-9/51

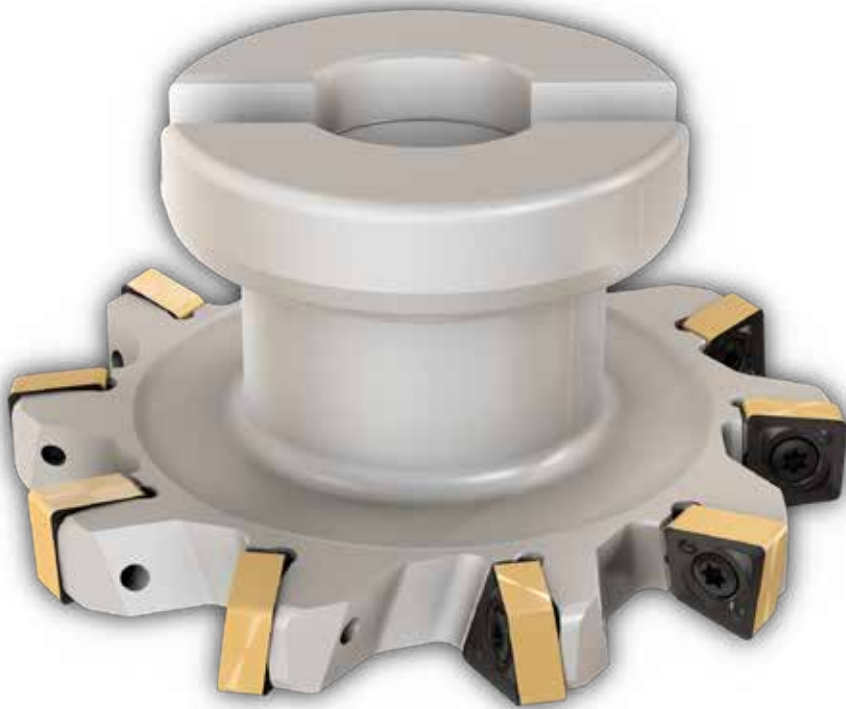

HELISLOT

SDN-XN09

Full Slot Disk Type Slotting Cutters Carrying XNMMU 0904 Square Inserts with 4 Right- and 4 Left-Hand Cutting Edges

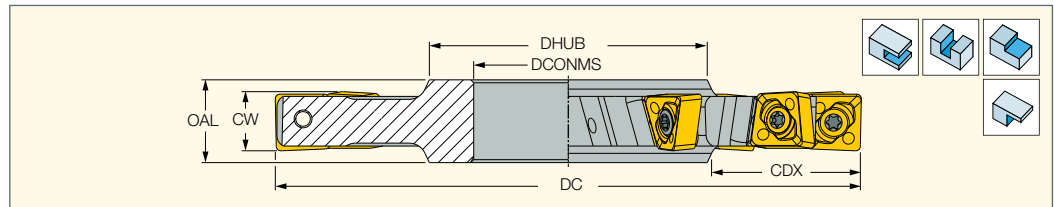

Designation	DC	CW	CICT ⁽¹⁾	ZEFP	CDX	DHUB	DCONMS	OAL	
SDN D080-10-27-XN09	80.00	10.00	10	10	20.00	38.00	27.00	14.00	0.20
SDN D080-12-27-XN09	80.00	12.00	10	5	20.00	38.00	27.00	16.00	0.24
SDN D100-10-32-XN09	100.00	10.00	12	12	25.00	47.00	32.00	14.00	0.34
SDN D100-12-32-XN09	100.00	12.00	12	6	25.00	47.00	32.00	16.00	0.42
SDN D125-10-40-XN09	125.00	10.00	14	14	34.00	55.00	40.00	14.00	0.61
SDN D125-12-40-XN09	125.00	12.00	14	7	34.00	55.00	40.00	16.00	0.69
SDN D160-10-40-XN09	160.00	10.00	18	18	51.00	55.00	40.00	14.00	0.61
SDN D160-12-40-XN09	160.00	12.00	18	9	51.00	55.00	40.00	16.00	1.10

⁽¹⁾ Number of inserts

Spare Parts

Designation		
SDN-XN09	SR 10508600	T-9/51

HELISLOT

ETS-XN09

T-SLOT Endmills Carrying XNMMU 0904 Square Inserts with 4 Right- and 4 Left-Hand Cutting Edges

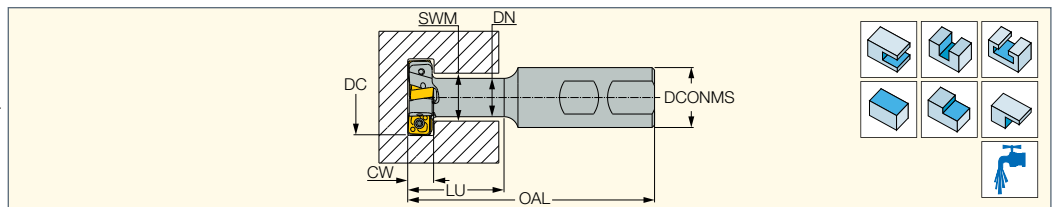

Designation	DC	CICT ⁽¹⁾	ZEFP	DN	SWM	CW	LU	OAL	DCONMS	Shank	
ETS D32-10-W16-XN09	31.70	4	2	15.50	18.00	9.90	35.00	85.00	16.00	W	0.02
ETS D32-11-W20-XN09	31.70	4	2	16.00	18.00	10.80	41.00	95.00	20.00	W	0.27
ETS D32-11-W25-XN09	31.70	4	2	16.00	18.00	10.80	41.00	105.00	25.00	W	0.62
ETS D32-14-W25-XN09	31.70	4	2	16.00	18.00	13.80	41.00	105.00	25.00	W	0.27
ETS D32-14-W32-XN09	31.70	4	2	16.00	18.00	13.80	45.00	110.00	32.00	W	0.88

⁽¹⁾ Number of inserts

Spare Parts

Designation		
ETS-XN09	SR 10508600	T-9/51



HELISLOT

XNMU 0904PN
 Square Inserts with 4 Right- and
 4 Left-Hand Cutting Edges

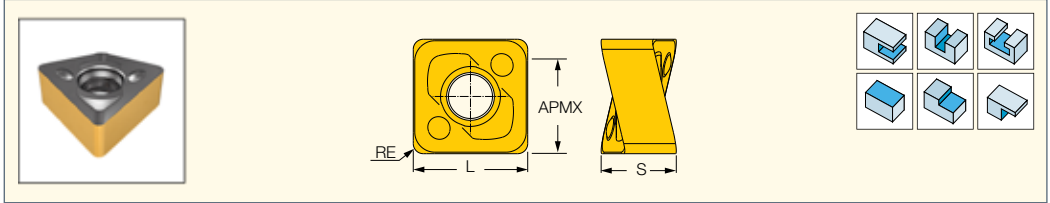

Designation	Dimensions				Tough \leftrightarrow Hard			Recommended Machining Data
	APMX	L	S	RE	IC830	IC5400	IC808	
XNMU 090408-PNTN	8.20	9.10	5.95	0.80	•	•	•	f_z (mm/t) 0.05-0.15

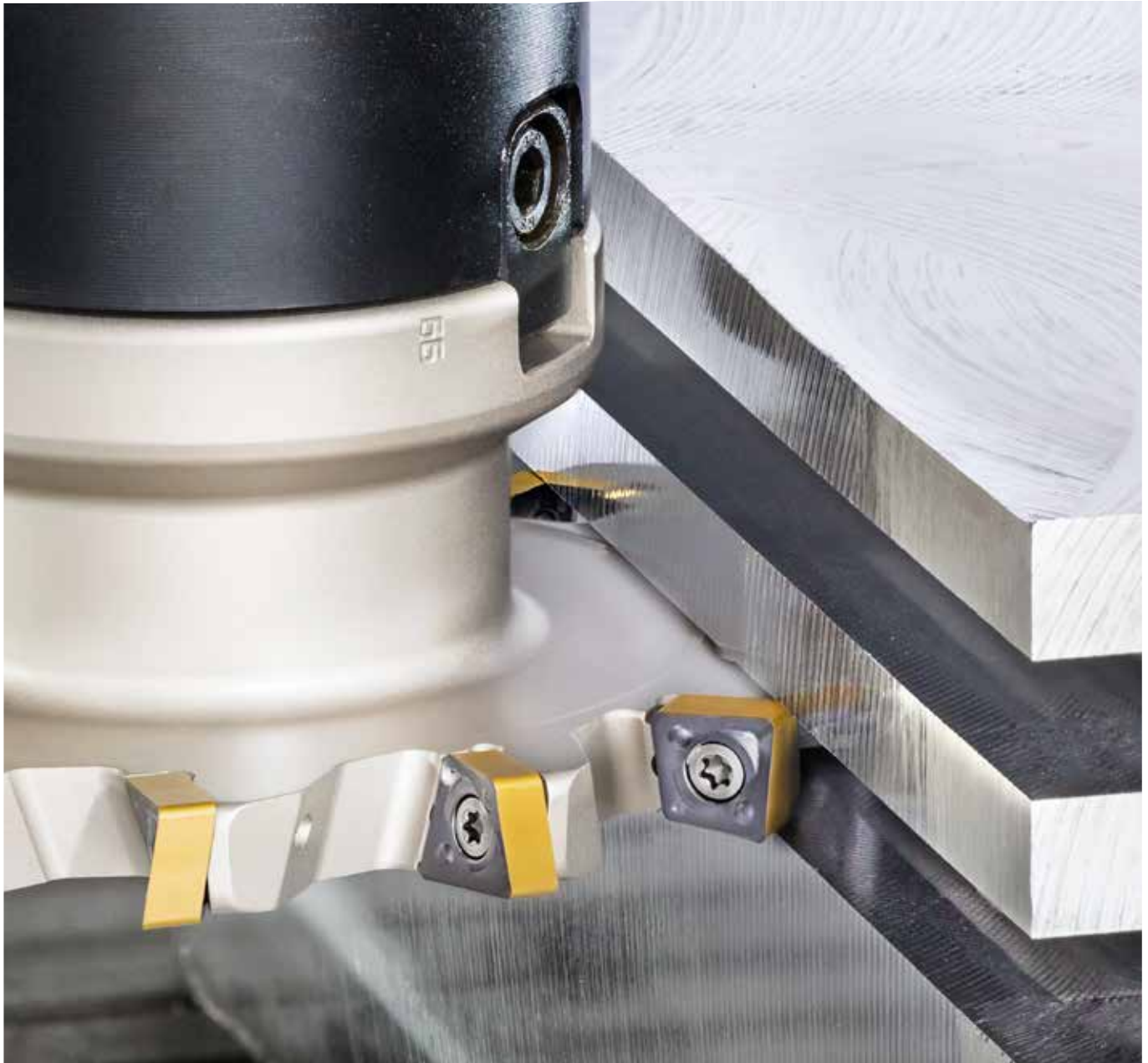



High Feed & Moderate Milling

NEOFEED
HIGH FEED LINE

Unique Insert with **8 Cutting Edges** Performs at **Fast Feed and Moderate Rates** for Different Milling Applications.



Size 12 mm Dia. Range for
Facemill 50-100

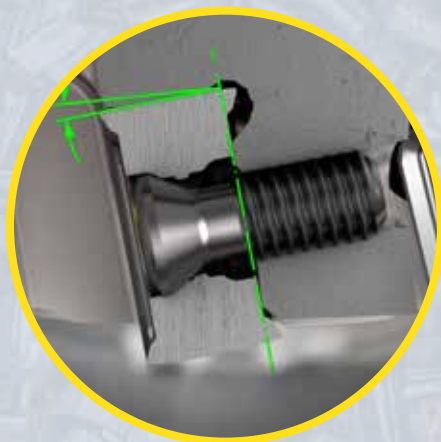

Dovetail Clamping Protects the
Insert from Disengaging

Suits All
Your Face
Milling
Needs



VIDEO



FFQ8-12

Fast Feed Face Mills Carrying
Double-Sided Inserts
with 8 Cutting Edges

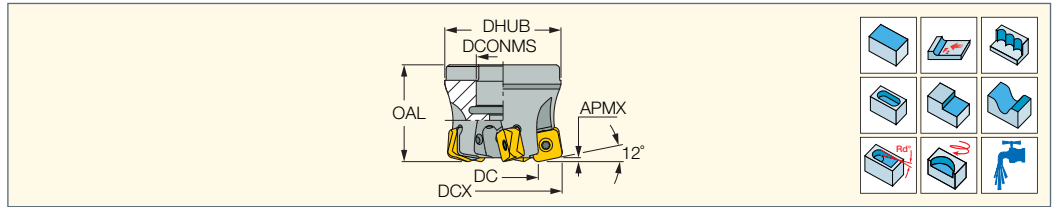

Designation	DC	DCX ⁽¹⁾	APMX	CICT ⁽²⁾	OAL	DHUB	DCONMS	Arbor	RMPX ⁽³⁾	MDN ⁽⁴⁾	MDX ⁽⁵⁾	MIID ⁽⁶⁾	
FFQ8 D050-05-22-12	30.60	50.00	1.50	5	40.00	48.00	22.00	A	0.3	80.60	99.00	FFQ8 SZMU 120520	0.46
FFQ8 D063-06-22-12	43.60	63.00	1.50	6	40.00	48.00	22.00	A	0.2	106.60	125.00	FFQ8 SZMU 120520	0.94
FFQ8 D080-07-27-12	60.60	80.00	1.50	7	50.00	60.00	27.00	A	0.2	140.60	159.00	FFQ8 SZMU 120520	1.98
FFQ8 D100-08-32-12	80.60	100.00	1.50	8	50.00	78.00	32.00	B	0.1	180.60	199.00	FFQ8 SZMU 120520	3.03

- Radius for programming 3.6 mm
- To generate a straight surface without cusps, the width of cut must not exceed DC
- For slot milling or machining with high tool overhang, the maximum depth of cut should be reduced by 30%.

⁽¹⁾ Cutting diameter maximum

⁽²⁾ Number of inserts

⁽³⁾ Maximum ramping angle

⁽⁴⁾ Machinable diameter minimum for interpolation

⁽⁵⁾ Machinable diameter maximum for interpolation

⁽⁶⁾ Master insert identification

Spare Parts

Designation				
FFQ8 D050-05-22-12	SR M4X0.7-L11.5 IP15	BLD IP15/S7	SW6-T-SH	SR M10X25 DIN912
FFQ8 D063-06-22-12	SR M4X0.7-L11.5 IP15	BLD IP15/S7	SW6-T-SH	SR M10X25 DIN912
FFQ8 D080-07-27-12	SR M4X0.7-L11.5 IP15	BLD IP15/S7	SW6-T-SH	SR M12X30DIN912
FFQ8 D100-08-32-12	SR M4X0.7-L11.5 IP15	BLD IP15/M7	SW6-T-SH	

FF
Fast Feed



MF
Moderate Feed

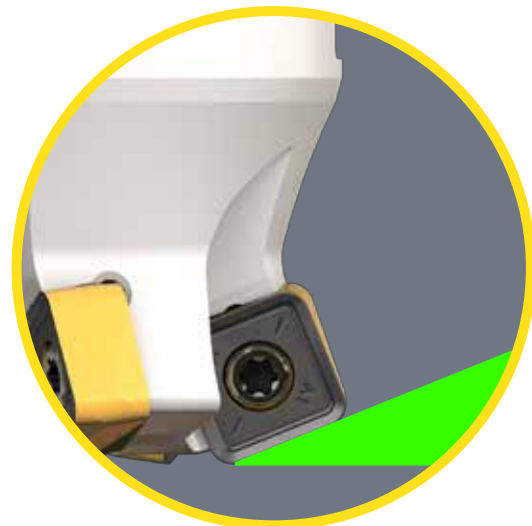

**One Insert for both
Fast Feed and Moderate Feed Milling**

MFQ8-12

Moderate Feed Face Mills
Carrying Double-Sided Inserts
with 8 Cutting Edges

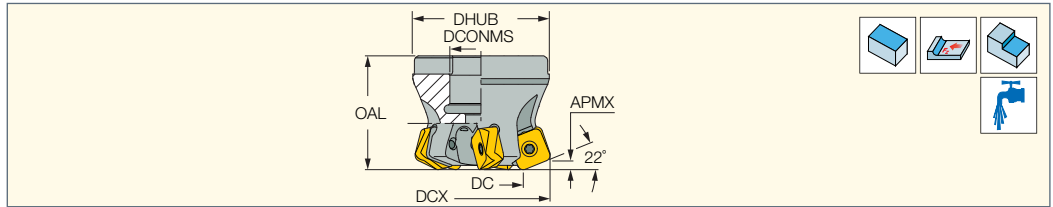

Designation	DC	DCX ⁽¹⁾	APMX	CICT ⁽²⁾	OAL	DHUB	DCONMS	Arbor	MIID ⁽³⁾	
MFQ8 D050-05-22-12	31.60	50.00	3.00	5	40.00	48.00	22.00	A	FFQ8 SZMU 120520	0.44
MFQ8 D063-06-22-12	44.60	63.00	3.00	6	40.00	48.00	22.00	A	FFQ8 SZMU 120520	0.84
MFQ8 D080-07-27-12	61.60	80.00	3.00	7	50.00	60.00	27.00	A	FFQ8 SZMU 120520	1.84
MFQ8 D100-08-32-12	81.60	100.00	3.00	8	50.00	78.00	32.00	B	FFQ8 SZMU 120520	2.95

• Radius for programming 5.0 mm • To generate a straight surface without cusps, the width of cut must not exceed DC • For slot milling or machining with high tool overhang, the maximum depth of cut should be reduced by 30%.

⁽¹⁾ Cutting diameter maximum

⁽²⁾ Number of inserts

⁽³⁾ Master insert identification

Spare Parts

Designation				
MFQ8 D050-05-22-12	SR M4X0.7-L11.5 IP15	BLD IP15/S7	SW6-T-SH	SR M10X40-1638
MFQ8 D063-06-22-12	SR M4X0.7-L11.5 IP15	BLD IP15/S7	SW6-T-SH	SR M10X25 DIN912
MFQ8 D080-07-27-12	SR M4X0.7-L11.5 IP15	BLD IP15/S7	SW6-T-SH	SR M12X30DIN912
MFQ8 D100-08-32-12	SR M4X0.7-L11.5 IP15	BLD IP15/M7	SW6-T-SH	



NEOFEED
HIGH FEED LINE

FFQ8 SZMU

Double-Sided Square
Inserts with 8 Cutting Edges
for High Feed Milling

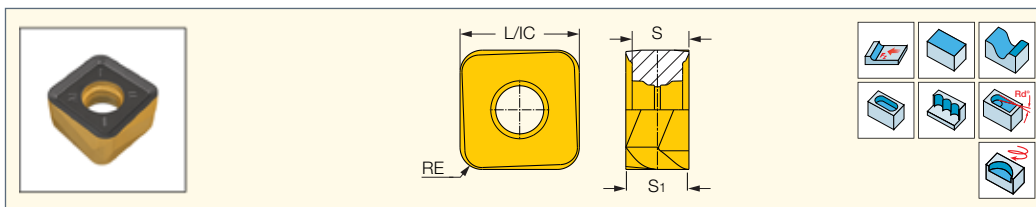

Designation	Dimensions				Tough ← Hard				Recommended Machining Data
	L	S	S1	RE	IC882	IC830	IC908	IC810	f_z (mm/t)
FFQ8 SZMU 120520HP	12.00	5.85	6.50	2.00	•	•	•		0.20-1.50
FFQ8 SZMU 120520T	12.00	5.85	6.50	2.00		•	•	•	0.40-1.50

• For side plunging, the initial cutting feed is 0.1 mm/t • T- for steel, ferritic and martensitic stainless steel, cast iron and hardened steel • HP - for austenitic stainless steel and high temperature alloys





Ø32 mm Cost Effective Indexable Milling Heads

MULTI-MASTER
INDEXABLE HEADS

New 32 mm MULTI-MASTER Head for Roughing, Semi-Finishing & Finishing with Ramp Down Capabilities for **Cost Savings and High Productivity.**



40,000 Indexable Solid Carbide Endmill Options



**NEW
32 mm
Head**



VIDEO



MM ECK-CF

5,6 Flute Solid Carbide Heads with 35°/38° Helix Featuring Different Corner Radii For Machining Titanium Alloys

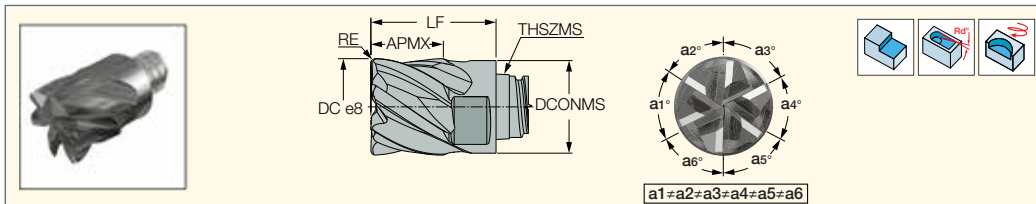

Designation	Dimensions									IC908	Recommended Machining Data
	DC	RE	NOF ⁽¹⁾	APMX	THSZMS	DCONMS	LF	RMPX ⁽²⁾	f_z (mm/t)		
MM ECK320H38R4-5T21	32.00	4.00	5	38.00	T21	30.00	55.00	1.0	•	0.06-0.18	
MM ECK320H38R5-5T21	32.00	5.00	5	38.00	T21	30.00	55.00	1.0	•	0.06-0.18	

• Do not apply lubricant to the threaded connection.

⁽¹⁾ Number of flutes

⁽²⁾ Maximum ramping angle

CHATTERFREE
MULTI-MASTER LINE

MM EC-CF

Interchangeable Solid Carbide Endmill Heads for CHATTERFREE Roughing and Finishing Operations

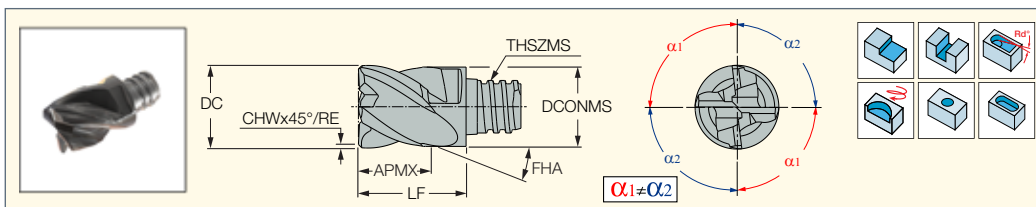

Designation	Dimensions										IC908	Recommended Machining Data
	DC	RE	NOF ⁽¹⁾	APMX	THSZMS	DCONMS	LF	FHA	CHW	KCH		f_z (mm/t)
MM EC320H38C06-4T21	32.00	-	4	38.00	T21	30.00	55.00	38.0	0.60	45.0	•	0.06-0.18

• Do not apply lubricant to the threaded connection.

⁽¹⁾ Number of flutes

MM S-A (stepped shanks)

Stepped Cylindrical Shanks Carrying Interchangeable Milling Heads

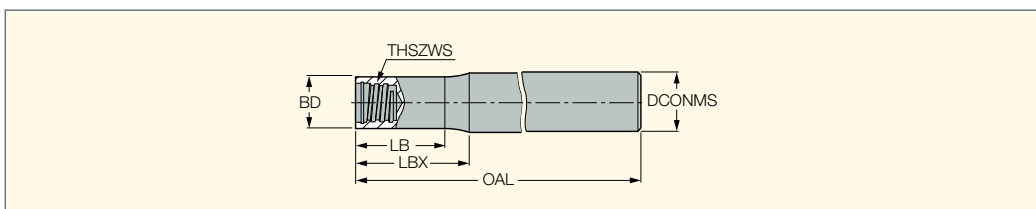

Designation	THSZWS	DCONMS	BD	LB	LBX	OAL	Shank ⁽¹⁾	Shank m. ⁽²⁾	CSP	RPMX ⁽³⁾	Kg
MM S-A-L100/32-C32-T21	T21	32.00	30.00	32.00	35.3	100.00	C	S	0	12690	0.56
MM S-A-L130/60-C32-T21-C	T21	32.00	30.00	60.00	63.3	130.00	C	C	0	12690	1.22
MM S-A-L135/64-C32T21C	T21	32.00	30.00	64.00	67.5	135.00	C	C	0	12690	1.02
MM S-A-L150/50-C32-T21	T21	32.00	30.00	50.00	53.5	150.00	C	S	0	12690	0.86
MM S-A-L170/100-C32-T21-C	T21	32.00	30.00	100.00	103.5	170.00	C	C	0	12690	1.22
MM S-A-L250/150-C32-T21-C	T21	32.00	30.00	150.00	153.5	250.00	C	C	0	12690	2.50
MM S-A-L300/200-C32-T21-C	T21	32.00	30.00	200.00	203.5	300.00	C	C	0	12690	3.00

• Do not apply lubricant to the threaded connection.

⁽¹⁾ C-Cylindrical

⁽²⁾ S-steel, C-carbide

⁽³⁾ The maximum RPM must be calculated. Divide the listed max. RPM by the number of flutes (on the milling head) being used.

MULTI-MASTER

MM S-B (85° conical shanks)
Shanks Carrying Interchangeable
Milling Heads

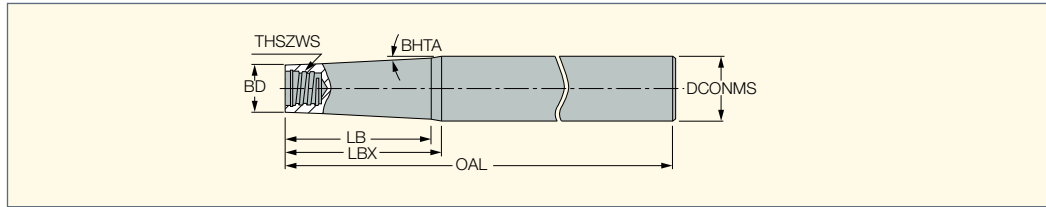

Designation	THSZWS	DCONMS	BD	BHTA	Shank ⁽¹⁾	LB	LBX	OAL	Shank m. ⁽²⁾	RPMX ⁽³⁾	
MM S-B-L150/57-C40T21	T21	40.00	30.00	5.0	C	-	57.0	150.00	S	21840	0.62

- Do not apply lubricant to the threaded connection.
- (1) C-Cylindrical
- (2) S-steel
- (3) The maximum RPM must be calculated. Divide the listed max. RPM by the number of flutes (on the milling head) being used.

MULTI-MASTER

MM S-A (straight shanks)
Shanks Carrying Interchangeable
Milling Heads

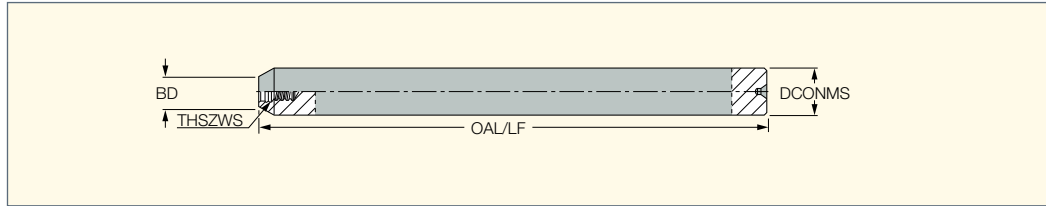

Designation	THSZWS	DCONMS	BD	OAL	Shank ⁽¹⁾	Shank m. ⁽²⁾	RPMX ⁽³⁾	
MM S-A-L100-C40T21	T21	40.00	30.00	100.00	C	S	60000	1.56

- Do not apply lubricant to the threaded connection.
- (1) C-Cylindrical
- (2) S-steel
- (3) The maximum RPM must be calculated. Divide the listed max. RPM by the number of flutes (on the milling head) being used.



**NEW
32 mm
Head**





75% Less Milling Passes with Barrel Heads

MULTI-MASTER
INDEXABLE HEADS

New Barrel Shaped
MULTI-MASTER Head for
Accurate Finishing Optimizes
Valuable Machining Time.

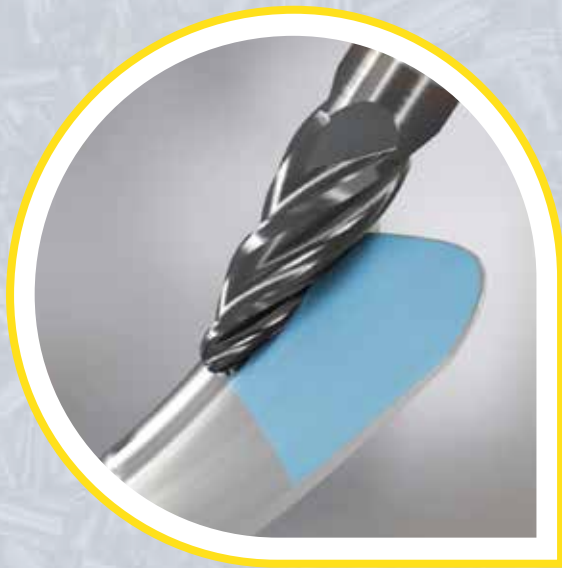

Barrel Shaped Head
Saves **up to 75% Passes**

**Extremely
Fast
Milling**



Range: Ø8 mm → Ø16 mm



VIDEO



MM ELB

Interchangeable Lens-Shaped (Barrel) Solid Carbide Heads for 3D Profiling

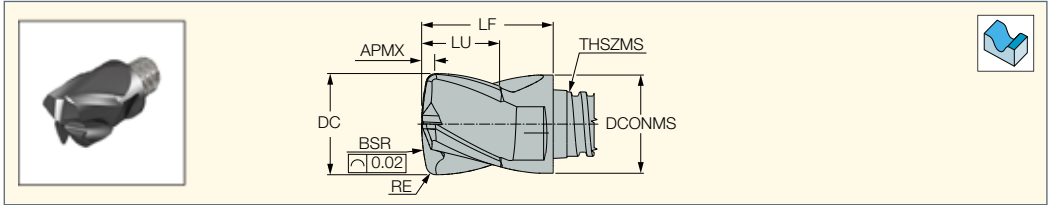

Designation	Dimensions									IC908
	DC	BSR	RE	LU	APMX	THSZMS	DCONMS	NOF ⁽¹⁾	LF	
MM ELB08R16A05-4T05	8.00	16.00	0.50	5.50	0.90	T05	8.00	4	10.00	●
MM ELB10R20A07-4T06	10.00	20.00	1.00	7.50	1.42	T06	10.00	4	13.00	●
MM ELB12R24A09-4T08	12.00	24.00	1.00	9.00	1.55	T08	12.00	4	16.50	●
MM ELB16R32A12-4T10	16.00	32.00	1.00	12.00	1.80	T10	16.00	4	20.50	●

⁽¹⁾ Number of flutes

MM EOB

Interchangeable Oval-Shaped (Barrel) Solid Carbide Heads for 3D Profiling

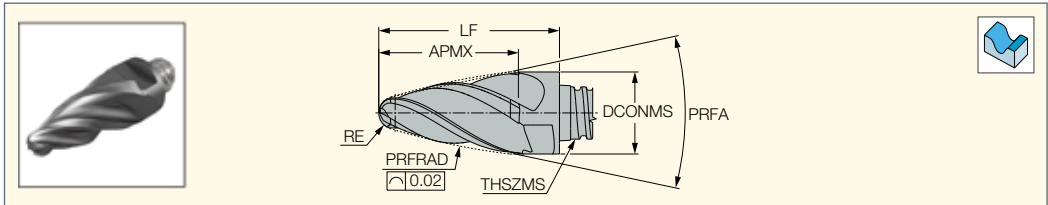

Designation	Dimensions									IC908
	PRFRAD	RE	APMX	PRFA	THSZMS	NOF ⁽¹⁾	DCONMS	LF		
MM EOB08R1.5R80A13-4T05	80.00	1.50	14.20	24.00	T05	4	8.00	18.00	●	
MM EOB10R2.0R85A16-4T06	85.00	2.00	16.50	24.00	T06	4	10.00	22.00	●	
MM EOB12R2.0R75A21-4T08	75.00	2.00	21.30	24.00	T08	4	12.00	27.00	●	
MM EOB16R3.0R75A26-4T10	75.00	3.00	27.00	24.00	T10	4	16.00	33.40	●	

⁽¹⁾ Number of flutes

SC ELB

Solid Carbide Lens-Shaped (Barrel) Endmills for 3D Profiling

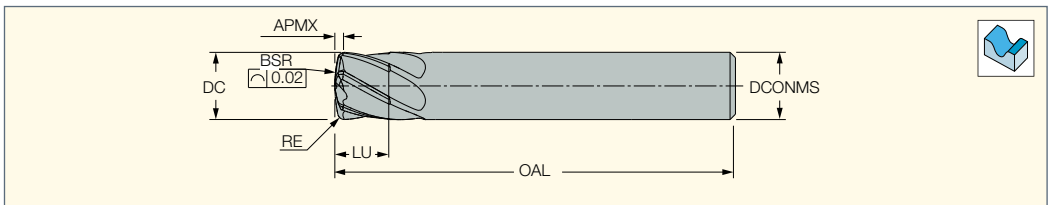

Designation	Dimensions									IC902
	DC	BSR	RE	LU	APMX	DCONMS	NOF ⁽¹⁾	OAL	Shank ⁽²⁾	
ELB-R0.75R16A5-6C8-63	8.00	15.00	0.75	5.00	1.10	8.00	4	63.00	C	●
ELB-R1R20A7-6C10-72	10.00	20.00	1.00	7.00	1.43	10.00	6	72.00	C	●
ELB-R1R25A9-6C12-83	12.00	25.00	1.00	9.00	1.53	12.00	6	83.00	C	●

⁽¹⁾ Number of flutes

⁽²⁾ C-Cylindrical

SC EOB
Solid Carbide Oval-Shaped
(Barrel) Endmills for 3D Profiling

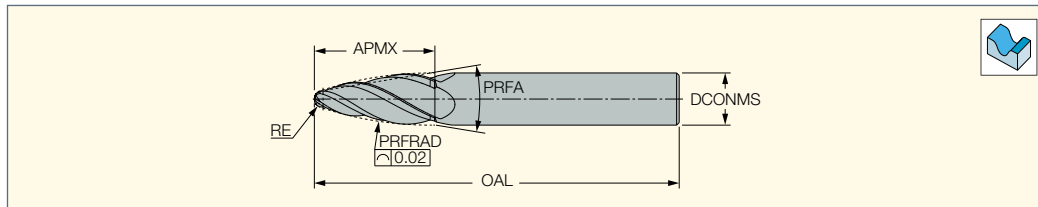

Designation	Dimensions								Shank ⁽²⁾	IC902
	PRFRAD	RE	APMX	PRFA	DCONMS	NOF ⁽¹⁾	OAL			
EOB-R1R90A24/7-4C08-63	90.00	1.00	24.80	14.88	8.00	4	63.00	C	●	
EOB-R2R85A24/8-4C10-72	85.00	2.00	26.60	15.46	10.00	4	72.00	C	●	
EOB-R2R80A27/9-4C12-83	80.00	2.00	27.10	18.38	12.00	4	83.00	C	●	

⁽¹⁾ Number of flutes

⁽²⁾ C-Cylindrical

SC ETB
Solid Carbide Tapered-Shaped
(Barrel) Endmills for 3D Profiling

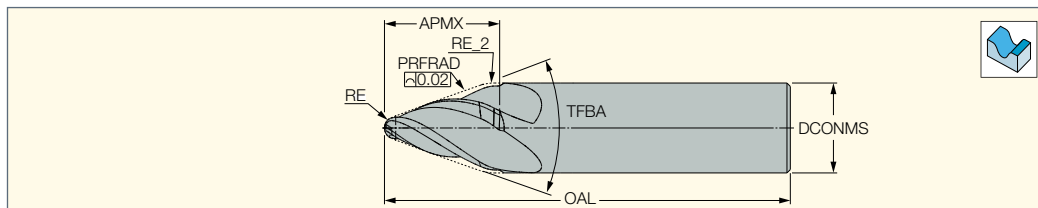

Designation	Dimensions								Shank ⁽²⁾	IC902
	PRFRAD	RE_2	RE	APMX	TFBA	DCONMS	NOF ⁽¹⁾	OAL		
ETB-R1R250A10/20-4C08-63	250.00	4.00	1.00	10.00	40.00	8.00	4	63.00	C	●
ETB-R2R250A11/20-4C10-72	250.00	5.00	2.00	11.00	40.00	10.00	4	72.00	C	●
ETB-R3R250A12/20-4C12-83	250.00	6.00	3.00	12.00	40.00	12.00	4	83.00	C	●

⁽¹⁾ Number of flutes

⁽²⁾ C-Cylindrical



Barrel Shaped Head
Saves **up to 75% Passes**



NEOLOGIQ HOLD

MACHINING INTELLIGENTLY



NEOCOLLET
INTEGRAL COLLET



Highly Rigid and Accurate Collet

NEOCOLLET
INTEGRAL COLLET

New Rigid Collet for
Small Diameter Solid Head
Milling Cutters.



Available for
ER16, 20, 25, 32, 40 Collet Chucks
with a Variety of Extension Sizes



Through-Tool Coolant
Directed to Cutter Edges

VIDEO



SD-S-A-ER-SP

Solid ER Collets with SD Spline Connection (SP)

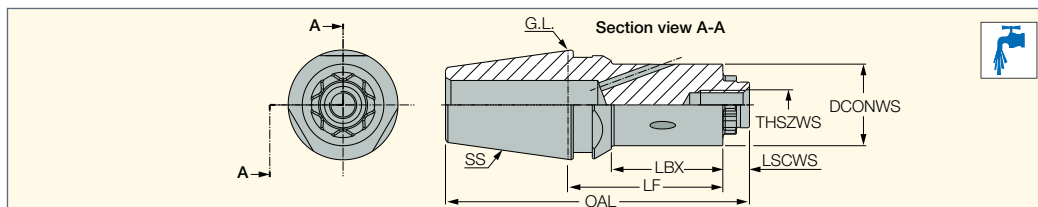



Designation	SS	LBX ⁽¹⁾	DCONWS	THSZWS	LSCWS	OAL	
SD-S-A-H05-ER16-SP11-C	ER16	5.00	11.00	M4X0.5	3.85	36.35	0.03
SD-S-A-H20-ER16-SP11-C	ER16	20.00	11.00	M4X0.5	3.85	51.35	0.04
SD-S-A-H05-ER20-SP11-C	ER20	5.00	11.00	M4X0.5	3.85	39.85	0.05
SD-S-A-H05-ER20-SP13-C	ER20	5.00	13.00	M4X0.5	4.35	40.35	0.05
SD-S-A-H05-ER20-SP15-C	ER20	5.00	15.00	M5X0.5	4.90	40.90	0.05
SD-S-A-H20-ER20-SP11-C	ER20	20.00	11.00	M4X0.5	3.85	54.85	0.06
SD-S-A-H20-ER20-SP13-C	ER20	20.00	13.00	M4X0.5	4.35	55.35	0.07
SD-S-A-H20-ER20-SP15-C	ER20	20.00	15.00	M5X0.5	4.90	55.90	0.08
SD-S-A-H05-ER25-SP11-C	ER25	5.00	11.00	M4X0.5	3.85	42.85	0.09
SD-S-A-H05-ER25-SP13-C	ER25	5.00	13.00	M4X0.5	4.35	43.35	0.09
SD-S-A-H05-ER25-SP15-C	ER25	5.00	15.00	M5X0.5	4.90	43.90	0.09
SD-S-A-H05-ER25-SP17-C	ER25	5.00	17.00	M6X0.5	6.00	45.00	0.09
SD-S-A-H05-ER25-SP19-C	ER25	5.00	19.00	M6X0.5	8.50	47.50	0.09
SD-S-A-H20-ER25-SP11-C	ER25	20.00	11.00	M4X0.5	3.85	57.85	0.10
SD-S-A-H20-ER25-SP13-C	ER25	20.00	13.00	M4X0.5	4.35	58.35	0.10
SD-S-A-H20-ER25-SP15-C	ER25	20.00	15.00	M5X0.5	4.90	58.90	0.11
SD-S-A-H20-ER25-SP17-C	ER25	20.00	17.00	M6X0.5	6.00	60.00	0.12
SD-S-A-H20-ER25-SP19-C	ER25	20.00	19.00	M6X0.5	8.50	62.50	0.13
SD-S-A-H05-ER32-SP13-C	ER32	5.00	13.00	M4X0.5	4.35	49.35	0.14
SD-S-A-H05-ER32-SP15-C	ER32	5.00	15.00	M5X0.5	4.90	49.90	0.15
SD-S-A-H05-ER32-SP17-C	ER32	5.00	17.00	M6X0.5	6.00	51.00	0.15
SD-S-A-H05-ER32-SP19-C	ER32	5.00	19.00	M6X0.5	8.50	53.50	0.15
SD-S-A-H20-ER32-SP13-C	ER32	20.00	13.00	M4X0.5	4.35	64.35	0.16
SD-S-A-H20-ER32-SP15-C	ER32	20.00	15.00	M5X0.5	4.90	64.90	0.16
SD-S-A-H20-ER32-SP17-C	ER32	20.00	17.00	M6X0.5	6.00	66.00	0.17
SD-S-A-H20-ER32-SP19-C	ER32	20.00	19.00	M6X0.5	8.50	68.50	0.18
SD-S-A-H05-ER40-SP17-C	ER40	5.00	17.00	M6X0.5	6.00	57.00	0.26
SD-S-A-H05-ER40-SP19-C	ER40	5.00	19.00	M6X0.5	8.50	59.20	0.27
SD-S-A-H20-ER40-SP17-C	ER40	20.00	17.00	M6X0.5	6.00	72.00	0.29
SD-S-A-H20-ER40-SP19-C	ER40	20.00	19.00	M6X0.5	8.50	74.50	0.30

⁽¹⁾ After the nut is mounted



**Through-Tool Coolant
Directed to Cutter Edges**

Spare Parts

Designation			
SD-S-A-H05-ER16-SP11-C	SR M4X0.5-SP11 HG	SW6-T-SH	BLD T15/S7
SD-S-A-H20-ER16-SP11-C	SR M4X0.5-SP11 HG	SW6-T-SH	BLD T15/S7
SD-S-A-H05-ER20-SP11-C	SR M4X0.5-SP11 HG	SW6-T-SH	BLD T15/S7
SD-S-A-H05-ER20-SP13-C	SR M4X0.5-SP13-IP15-HG	SW6-T-SH	BLD IP15/S7
SD-S-A-H05-ER20-SP15-C	SR M5X0.5-SP15-IP20-HG	SW6-T-SH	BLD IP20/S7
SD-S-A-H20-ER20-SP11-C	SR M4X0.5-SP11 HG	SW6-T-SH	BLD T15/S7
SD-S-A-H20-ER20-SP13-C	SR M4X0.5-SP13-IP15-HG	SW6-T-SH	BLD IP15/S7
SD-S-A-H20-ER20-SP15-C	SR M5X0.5-SP15-IP20-HG	SW6-T-SH	BLD IP20/S7
SD-S-A-H05-ER25-SP11-C	SR M4X0.5-SP11 HG	SW6-T-SH	BLD T15/S7
SD-S-A-H05-ER25-SP13-C	SR M4X0.5-SP13-IP15-HG	SW6-T-SH	BLD IP15/S7
SD-S-A-H05-ER25-SP15-C	SR M5X0.5-SP15-IP20-HG	SW6-T-SH	BLD IP20/S7
SD-S-A-H05-ER25-SP17-C	SR M6X0.5-SP17-IP20-HG	SW6-T-SH	BLD IP20/S7
SD-S-A-H05-ER25-SP19-C	SR M6X0.5-SP17-IP20-HG	SW6-T-SH	BLD IP20/S7
SD-S-A-H20-ER25-SP11-C	SR M4X0.5-SP11 HG	SW6-T-SH	BLD T15/S7
SD-S-A-H20-ER25-SP13-C	SR M4X0.5-SP13-IP15-HG	SW6-T-SH	BLD IP15/S7
SD-S-A-H20-ER25-SP15-C	SR M5X0.5-SP15-IP20-HG	SW6-T-SH	BLD IP20/S7
SD-S-A-H20-ER25-SP17-C	SR M6X0.5-SP17-IP20-HG	SW6-T-SH	BLD IP20/S7
SD-S-A-H20-ER25-SP19-C	SR M6X0.5-SP17-IP20-HG	SW6-T-SH	BLD IP20/S7
SD-S-A-H05-ER32-SP13-C	SR M4X0.5-SP13-IP15-HG	SW6-T-SH	BLD IP15/S7
SD-S-A-H05-ER32-SP15-C	SR M5X0.5-SP15-IP20-HG	SW6-T-SH	BLD IP20/S7
SD-S-A-H05-ER32-SP17-C	SR M6X0.5-SP17-IP20-HG	SW6-T-SH	BLD IP20/S7
SD-S-A-H05-ER32-SP19-C	SR M6X0.5-SP17-IP20-HG	SW6-T-SH	BLD IP20/S7
SD-S-A-H20-ER32-SP13-C	SR M4X0.5-SP13-IP15-HG	SW6-T-SH	BLD IP15/S7
SD-S-A-H20-ER32-SP15-C	SR M5X0.5-SP15-IP20-HG	SW6-T-SH	BLD IP20/S7
SD-S-A-H20-ER32-SP17-C	SR M6X0.5-SP17-IP20-HG	SW6-T-SH	BLD IP20/S7
SD-S-A-H20-ER32-SP19-C	SR M6X0.5-SP17-IP20-HG	SW6-T-SH	BLD IP20/S7
SD-S-A-H05-ER40-SP17-C	SR M6X0.5-SP17-IP20-HG	SW6-T-SH	BLD IP20/S7
SD-S-A-H05-ER40-SP19-C	SR M6X0.5-SP17-IP20-HG	SW6-T-SH	BLD IP20/S7
SD-S-A-H20-ER40-SP17-C	SR M6X0.5-SP17-IP20-HG	SW6-T-SH	BLD IP20/S7
SD-S-A-H20-ER40-SP19-C	SR M6X0.5-SP17-IP20-HG	SW6-T-SH	BLD IP20/S7





NEOLOGIQ GRADES

MACHINING INTELLIGENTLY

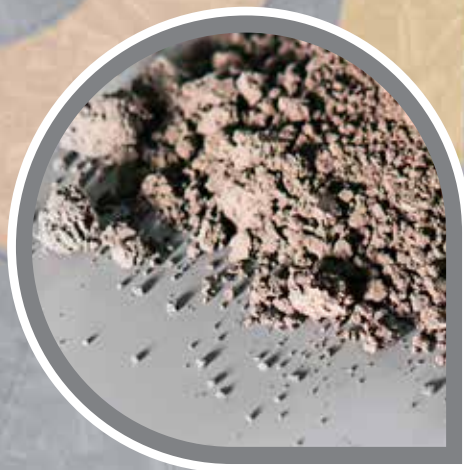

Turning Grades

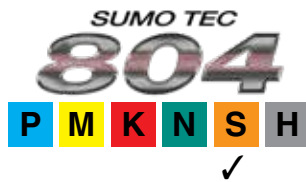

A very hard submicron grain size substrate with PVD coating and a special SUMOTEC surface treatment. Suitable for semi-finishing and finishing operations under stable conditions on high temperature alloys and Titanium alloys moderate to relatively high cutting speeds. Features high wear resistance and plastic deformation durability.

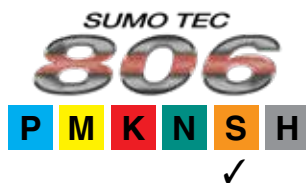

A hard submicron grain size substrate with PVD coating and a special SUMOTEC surface treatment. Excellent for machining high temperature alloys and Titanium alloys, at moderate to relatively high cutting speeds. Features high wear resistance and plastic deformation durability.



A hard submicron grain size substrate with PVD coating and a special SUMOTEC surface treatment. Suitable for machining steels, alloy steels, austenitic stainless steel, high temperature alloys and hard steels at moderate to relatively high cutting speeds under stable conditions. Features high wear resistance and plastic deformation durability.

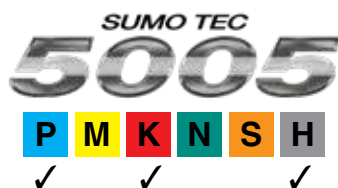

A very hard substrate with MTCVD coating with a special SUMOTEC surface treatment. Suitable for machining gray and nodular cast iron at high cutting speeds under stable conditions.



A hard substrate with MTCVD coating with a special SUMOTEC surface treatment. Recommended for machining gray and nodular cast iron at moderate to high cutting speeds, provides very good resistance to chipping.

Turning Grades



A hard substrate with cobalt enriched outer layer and MTCVD coating and a special SUMOTEC surface treatment. Suitable for finishing and medium turning of stainless steel at high cutting speeds. Features long tool life and high wear resistance.



A very tough substrate with MTCVD coating with a special SUMOTEC surface treatment. Recommended for machining stainless steel at moderate cutting speeds and medium to high feeds. Features very high toughness with excellent results in heavy machining operations, unstable conditions, and interrupted cut.



A hard substrate with a cobalt enriched layer, MTCVD coating with a special SUMOTEC surface treatment. Recommended for high speed machining of steels, alloy steels and martensitic stainless steel with moderate feeds under stable conditions. Features excellent thermal stability, resistance to wear and plastic deformation durability.



A tough substrate with a cobalt enriched layer and MTCVD coating with a special SUMOTEC surface treatment. Recommended for general use machining of steels, alloy steels and martensitic stainless steel in a wide range of conditions. Features high toughness and good wear resistance.



A very tough substrate with cobalt enriched layer and MTCVD coating and a special SUMOTEC surface treatment. Suitable for machining steels and alloy steels at low to medium cutting speeds and medium to high feeds. Features very high toughness with excellent results in heavy machining, unstable conditions, and interrupted cuts.

Parting Grades



A hard submicron grain size substrate with PVD coating and a special SUMOTEC surface treatment. Suitable for machining steels, alloy steels, austenitic stainless steel, high temperature alloys and hard steels at moderate to relatively high cutting speeds under stable conditions. Features high wear resistance and plastic deformation durability.

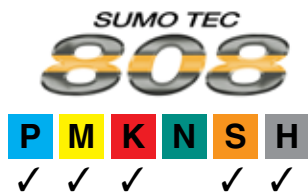

A tough submicron grain size substrate with PVD coating and a special SUMOTEC surface treatment. Recommended for general use for a large variety of applications and materials such as steels, alloy steels, austenitic stainless steel and high temperature alloys at moderate cutting speeds and feeds. Features high wear resistance and chipping durability.

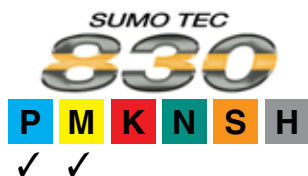

A tough substrate with PVD coating and a special SUMOTEC surface treatment. Suitable for machining steel and stainless steel at low to medium cutting speeds and moderate to high feeds. The grade features high toughness and recommended for interrupted cuts and machining under unstable conditions. May be used on high temperature alloys at low cutting speeds.



A tough submicron grain size substrate with PVD coating. Recommended for general use on a wide range of applications and materials such as steels, alloy steels, austenitic stainless steel and high temperature alloys at moderate cutting speeds and low to medium feeds. The grade features improved toughness and wear resistance which extends tool life.



A tough substrate with PVD coating, suitable for machining steel and stainless steel at low to medium cutting speeds and moderate to high feeds. Recommended for interrupted cuts and machining under unstable conditions. The grade features improved toughness and wear resistance which extends tool life.

Drilling Grades



A tough submicron grain size substrate with PVD coating, recommended for general use in a large variety of operations and materials such as steels, alloy steels, austenitic stainless steel and high temperature alloys at moderate cutting speeds. Features high wear resistance and chipping durability.



A tough substrate with SUMOTEC CVD coating. Recommended for high speed drilling of steel. Provides excellent tool life.



A submicron grain size substrate with SUMOTEC MTCVD coating. Features excellent chipping and wear resistance. Recommended for high speed drilling of cast iron and steel, to be used for the peripheral insert on DR drills.

Milling Grades



A tough PVD coated grade with SUMOTEC surface treatment. Used for milling a wide range of workpiece materials, at low to medium cutting speeds and for unstable machining conditions.

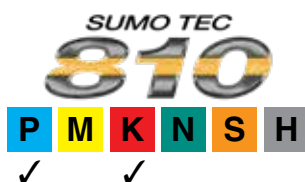

A SUMOTEC PVD coated grade. Optimal choice for milling nodular cast iron at medium to high cutting speeds.

Milling Grades



A tough substrate with PVD coating and a special SUMOTEC surface treatment. Suitable for machining steel and stainless steel at low to medium cutting speeds and moderate to high feeds. The grade features high toughness and recommended for interrupted cuts and machining under unstable conditions. May be used on high temperature alloys at low cutting speeds.



A PVD coated tough grade followed by a special surface treatment. Suitable for milling austenitic stainless steel and high temperature alloys. Recommended for interrupted cuts and heavy operations.



A PVD coated tough grade followed by a special SUMOTEC surface treatment. Designed for milling alloyed steel, especially when used for interrupted cuts and heavy operations.

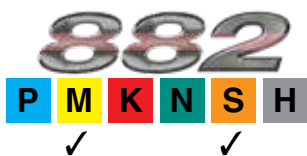

A grade with a tough substrate, a with PVD coating and a special surface treatment. Designed for machining austenitic stainless steel, Titanium and high temperature alloys, particularly under hard cutting conditions.

Milling Grades



A tough submicron grain size substrate with PVD coating, recommended for general use in a large variety of operations and materials such as steels, alloy steels, austenitic stainless steel and high temperature alloys at moderate cutting speeds. Features high wear resistance and chipping durability.

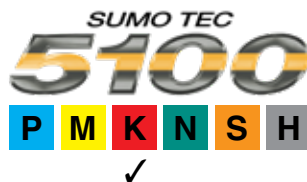

A CVD multi-layer coating with SUMOTEC post coating surface treatment. Recommended for milling grey cast iron at high cutting speeds, and provides extended tool life.



A tough substrate with MTCVD coating. Recommended for milling steel at high cutting speed and for parting stainless steel.

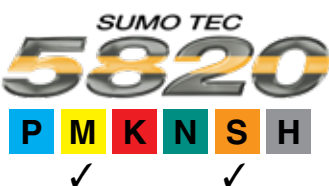

A tough substrate, with a MTCVD coating and special SUMOTEC post coating surface treatment. Designed for machining austenitic stainless steel, Titanium and high temperature alloys.



THE STANDARDS INSTITUTION OF ISRAEL



THE STANDARDS INSTITUTION OF ISRAEL



THE STANDARDS INSTITUTION OF ISRAEL



THE STANDARDS INSTITUTION OF ISRAEL



THE STANDARDS INSTITUTION OF ISRAEL

Quality Standard

ISCAR has been certified by the prestigious Standards Institution, as being in full compliance to ensure delivery of the finest quality goods. Quality control facilities include the metallurgical laboratory, raw metal testing, an online testing procedure and a machining center for tool performance testing and final product inspection. Only the finest products are packaged for entry into ISCAR's inventory.

ISCAR LTD.**Israel****Headquarters**

Tel +972 (0)4 997 0311
 Fax+972 (0)4 987 3741
 headquarter@iscar.co.il

Argentina

ISCAR TOOLS ARGENTINA SA
 Tel +54 114 912 2200
 Fax+54 114 912 4411
 admin@iscararg.com.ar

Australia

ISCAR AUSTRALIA PTY. LTD
 Tel +61 (0) 2 8848 3500
 Fax+61 (0) 2 8848 3511
 iscaraus@iscar.com.au

Austria

ISCAR AUSTRIA GmbH
 Tel +43 7252 71200-0
 Fax+43 7252 71200-999
 office@iscar.at

Belarus

JV ALC "TWING-M"
 Tel +375 17 506-32-38
 +375 17 506-33-31/65
 Tel/Fax +375 17 506-32-37
 info@twing.by
 www.twing.by

Belgium

n.v. ISCAR BENELUX s.a.
 Tel +32 (0) 2 464 2020
 Fax+32 (0) 2 522 5121
 info@iscar.be

Bosnia

(Representative Office)
 Tel +387 32 201 100
 Fax+387 32 201 101
 info@iscar.ba

Brazil

ISCAR DO BRASIL COML. LTDA.
 Tel +55 19 3826-7100
 Fax+55 19 3826-7171
 DDG 0800 701 8877
 iscar@iscarbrasil.com.br

Bulgaria

ISCAR BULGARIA
 Tel/Fax +359 431 62557
 aa_iscar@infotel.bg

Canada

ISCAR TOOLS INC.
 Tel +1 905 829 9000
 Fax+1 905 829 9100
 admin@iscar.ca

Chile

J&A INTERNATIONAL
 Tel +56 2 2232 5838
 amedina@jya.cl
 www.jya.cl

China

ISCAR CHINA
 Tel +86 21 8024 8888
 iscar@iscar.com.cn

Colombia

ISCAR Andina
 Tel +57 310 380 9932
 Tel/fax +57 1 896 65 78
 iscar@iscar.com.co

Croatia

ISCAR ALATI d.o.o.
 Tel +385 (0) 1 33 23 301
 Fax+385 (0) 1 33 76 145
 iscar@zg.t-com.hr

Cyprus

WAMET (Demetriades) Ltd.
 Tel +357 (0) 2 336660/5498
 Fax+357 (0) 2 333386
 wamet@cytanet.com.cy

Czech Republic

ISCAR CR s.r.o.
 Tel +420 377 420 625
 Fax+420 377 420 630
 iscar@iscar.cz

Denmark

KJ VAERKTOEJ AS/ISCAR DENMARK
 Tel +45 70 11 22 44
 Fax+45 46 98 67 10
 kj@kj.dk

Ecuador

ISCAR Andina
 Tel/fax +57 1 821 93 38
 iscar@iscar.com.co
 atencioncliente@iscar.com.co

Estonia

KATOMSK AS
 Tel +372 6775 671
 Fax+372 6720 266
 aleksei@katomsk.ee

Finland

ISCAR FINLAND OY
 Tel +358-(0)9-439 1420
 Fax+358-(0)9-466 328
 info@iscar.fi

France

ISCAR FRANCE SAS
 Tel +33 (0)1 30 12 92 92
 Fax+33 (0)1 30 12 95 82
 info@iscar.fr

Germany

ISCAR Germany GmbH
 Tel +49 (0) 72 43 9908-0
 Fax+49 (0) 72 43 9908-93
 gmbh@iscar.de
 www.iscar.de

Greece

INTERNATIONAL TOOLS
 K.-X. GEORGOPOULOS & SIA O.E
 Tel +30 210 346 0133
 Fax+30 210 342 5621
 info@internationaltools.gr

VIMA

V. Mazloumian & Sons
 Tel +30 2310 517-117 / 544-521
 Fax+30 2310 529-107
 vimaco@otenet.gr
 http://www.vimaco.gr

Hong Kong

MTC TOOLING SYSTEMS LTD
 Tel +85-2-23054838
 Fax+85-2-27988789
 yoongkamsing@hotmail.com

Hungary

ISCAR HUNGARY KFT.
 Tel +36 28 887 700
 Fax+36 28 887 710
 iscar@iscar.hu

India

ISCAR India Ltd.
 Tel +91 77009 63707
 sales@iscar.in

Indonesia

CV MULTI TEKNIK
 Tel +62-21-29206242/44/45/59
 Fax+62-21-29206243
 contact@multi-teknik.co.id

Ireland

HARD METAL MACHINE TOOLS
 Tel +353 (0) 1 286 2466
 Fax+353 (0) 1 286 1514
 phannigan@hardmetal.ie
 www.hardmetal.ie

Italy

ISCAR ITALIA srl
 Tel +39 02 93 528 1
 Fax+39 02 93 528 213
 marketing@iscaritalia.it

Japan

ISCAR JAPAN LTD.
 Tel +81 6 6835 5471
 Fax+81 6 6835 5472
 iscar@iscar.co.jp

Latvia

MECHA, UAB
 Tel +370 37 407 230
 Fax+370 37 407 231
 info@mecha.lt

Lithuania

MECHA, UAB
 Tel +370 37 407 230
 Fax+370 37 407 231
 sigitas@mecha.lt

Mexico

ISCAR DE MÉXICO
 Tel +52 (442) 214 5505
 Fax+52 (442) 214 5510
 iscar-mex@iscar.com.mx

The Netherlands

ISCAR NEDERLAND B.V.
 Tel +31 (0) 182 535523
 Fax+31 (0) 182 572777
 info@iscar.nl

New Zealand

ISCAR PACIFIC LTD.
 Tel +64 (0) 9 573 1280
 Fax+64 (0) 9 573 0781
 iscar@iscarpac.co.nz

North Macedonia

(Representative Office)
 Tel +389 2 309 02 52
 Fax+389 2 309 02 54
 info@iscar.com.mk

Norway

SVEA MASKINER AS
 Tel +47 32277750
 Fax+47 32277751
 per.martin.bakken@svea.no

Peru

HARTMETALL SAC
 Tel: (511) 6612699
 otorres@hartmetallgroup.com

Philippines

MESCO
 Tel +63 2631 1775
 Fax+63 2635 0276
 mesco@mesco.com.ph

Poland

ISCAR POLAND Sp. z o.o.
 Tel +48 32 735 7700
 Fax+48 32 735 7701
 iscar@iscar.pl

Portugal

ISCAR Portugal, SA
 Tel +351 256 579950
 Fax+351 256 586764
 info@iscarportugal.pt

Romania

ISCAR Tools SRL
 Tel +40 (0)312 286 614
 Fax+40 (0)312 286 615
 iscar-romania@iscar.com

Russia

Moscow
 ISCAR LLC
 Tel/fax +7 495 660 91 25/31
 iscar@iscar.ru

Serbia

ISCAR TOOLS d.o.o.
 Tel +381 11 314 90 38
 Fax+381 11 314 91 47
 info@iscartools.rs

Singapore

SINO TOOLING SYSTEM
 Tel +65 6566 7668
 Fax+65 6567 7336
 sinotool@singnet.com.sg

Slovakia

ISCAR SR, s.r.o.
 Tel +421 (0) 41 5074301
 Fax+421 (0) 41 5074311
 info@iscar.sk

Slovenia

ISCAR SLOVENIJA d.o.o.
 Tel +386 1 580 92 30
 Fax+386 1 562 21 84
 info@iscar.si

South Africa

ISCAR SOUTH AFRICA (PTY) LTD.
 ShareCall 08600-47227
 Tel +27 11 997 2700
 Fax+27 11 388 9750
 iscar@iscarsa.co.za

South Korea

ISCAR KOREA
 Tel +82 53 760 7594
 Fax+82 53 760 7500
 leeyj@taegutec.co.kr

Spain

ISCAR IBERICA SA
 Tel +34 93 594 6484
 Fax+34 93 582 4458
 iscar@iscarib.es

Sweden

ISCAR SVERIGE AB
 Tel +46 (0) 18 66 90 60
 Fax+46 (0) 18 122 920
 info@iscar.se

Switzerland

ISCAR HARTMETALL AG
 Tel +41 (0) 52 728 0850
 Fax+41 (0) 52 728 0855
 office@iscar.ch

Taiwan

ISCAR Taiwan Ltd.
 Tel +886 (0)4-24731573
 Fax+886 (0)4-24731530
 iscar.taiwan@msa.hinet.net

Thailand

ISCAR Thailand Ltd.
 Tel +66 (2) 7136633-8
 Fax+66 (2) 7136632
 iscar@iscarthailand.com

Turkey

ISCAR Kesici Takim
 TIC. VE. IML. LTD
 Tel +90 (262) 751 04 84 (Pbx)
 Fax+90 (262) 751 04 85
 iscar@iscar.com.tr

Ukraine

ISCAR UKRAINE LLC
 Tel +38 (050) 440 23 91
 info@iscar.com.ua

United Arab Emirates

SVRS General Trading LLC
 Tel +971 4 342 6699
 www.svrs-mena.com

United Kingdom

ISCAR TOOLS LTD.
 Tel +44 (0) 121 422 8585
 Fax+44 (0) 121 423 2789
 sales@iscar.co.uk

United States

ISCAR METALS INC.
 Tel +1 817 258 3200
 Tech Tel 1-877-BY-ISCAR
 Fax+1 817 258 3221
 info@iscarmetals.com

Venezuela

FERREINDUSTRIAL ISO-DIN C.A.
 Tel +58 2 632 8211/633 4657
 Fax+58 2 632 5227
 iso-din@cantv.net

Vietnam

ISCAR VIETNAM
 (Representative Office)
 Tel +84 8 38 123 519/20
 Fax+84 8 38 123 521
 iscarvn@hcm.fpt.vn

www.iscar.com

Please check ISCAR's online catalog for the most current technical information regarding our products

Machine Intelligently with ISCAR's **NEOLOGIQ** Applications



All ISCAR's online apps, interfaces, and product catalogs in a single space

- | | | | | | | | |
|---|--|---|--|--|---|--|--|
| 
NEOLOGIQ | 
E-CAT | 
ISCAR | 
NPA | 
INDUSTREALIZE | 
FAQ | 
4.0 PRO | 
E-Commerce |
| 
Matrix | 
Machining Power | 
Publications | 
Productive Geometry | 
Grade Optimizer | 
Insert Wear | 
Chip Thinning | 
Media Channel |